

# KEAR

# 2017

## FABRICATION INC.

- *Glass Handling Equipment*
- *Material Handling Equipment*
- *Custom Fabrication*
- *Window Fabricating Equipment*

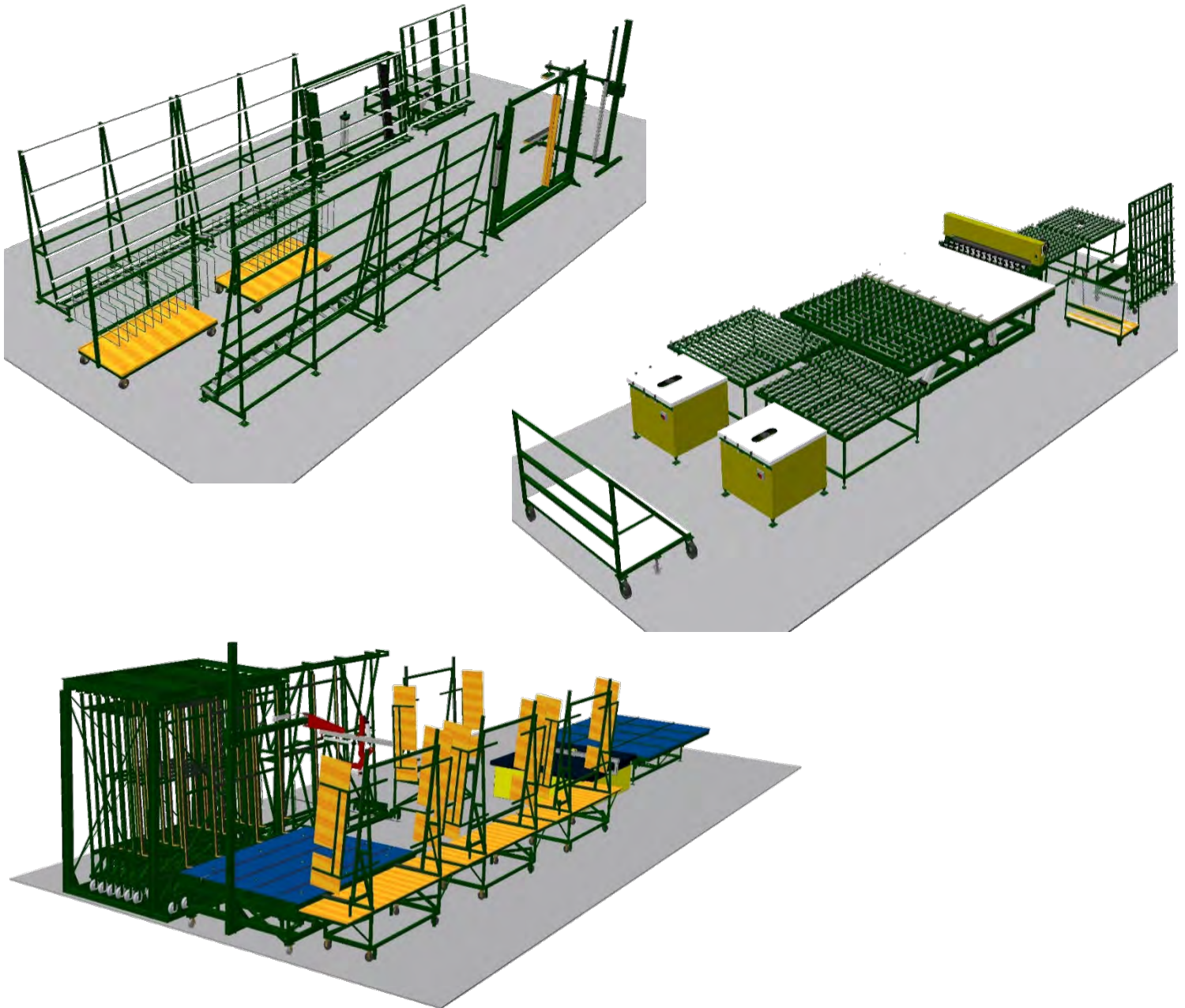

27 Vanley Crescent, North York, ON, Canada M3J 2B7 – Tel: (416) 398-8666 • Fax: (416) 398-9666

Toll Free: 1-866-760-0841



K-01F  
Full Base Harp Rack

K-01FPEL  
Full Base Harp Rack



K-01FT Harp Rack



K-01FDR Fiberglass  
Divider Rod



K-01FPICK Picking IG  
Harp Rack



K-01FDF  
Smooth Base



K-01FP Low Glass  
With Support Front Roller

**KEAR Fabrication Inc.**



K-01P  
Partial Base  
Harp Rack



K-01D Harp Rack  
For Door Storage



K-01DS  
Double Sided



K-1A  
Twin Level



K-01AA  
Multi- Level Harp Rack



K-01ROL Rollers base  
Stationary IG Rack



K-01LH  
File Dolly

# KEAR Fabrication Inc.



K-01AFP  
Twin Level  
With Extra full size



K-01AFF  
Full Base Twin Level  
With Extra full size



K-01AU  
Auto Claude Oven Rack



K-01TT  
Push Through Harp Rack



K-01T  
Oven Rack

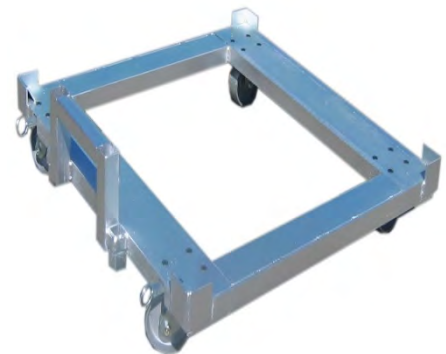

K-01AUB  
Mobile Base Oven Rack



K-01SP  
Shipping Harp Rack



K-01SPTR  
Triple Rod Shipping Rack

# KEAR Fabrication Inc.

27 Vanley Crescent, North York, Ont., Canada M3J 2B7 • Tel: (416) 398- 8666 • Fax: (416) 398-9666



K-01S  
For Shipping



K-01FRT  
Shipping Harp  
Rack



K-01STP  
Shipping Rack

K-01PTLE  
Pass Thru Low E  
Harp Rack



K-01FOD  
Double Rod Oversize Harp Rack



K-01OW  
Oversized Harp Rack  
(Width Oversize)



K-01FOS  
Stationary Oversize  
Harp Rack



# KEAR Fabrication Inc.



K-02  
Standard Float Table

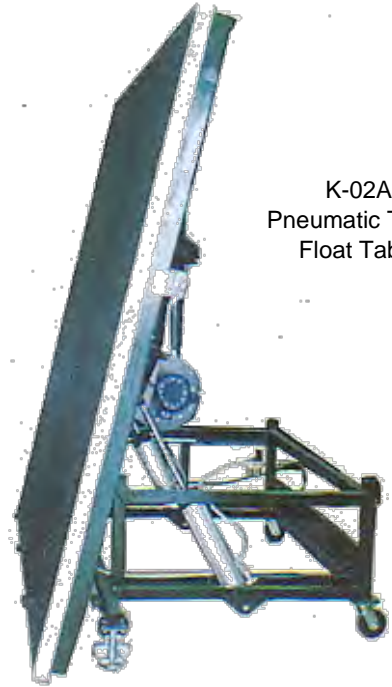

K-02A  
Pneumatic Tilting  
Float Table



K-02CB  
Counter-Balance Tilt Table



K-02B  
Break Out Table



K-2BJ  
Break Out Table for  
Jumbo Glass

# KEAR Fabrication Inc.

27 Vanley Crescent, North York, Ont., Canada M3J 2B7 • Tel: (416) 398- 8666 • Fax: (416) 398-9666



K-2HDC Hydraulic Tilt  
Aluminium Windows & Curtain  
Wall Packaging Table



K-2HDG Hydraulic Tilt Glass  
Packaging Table

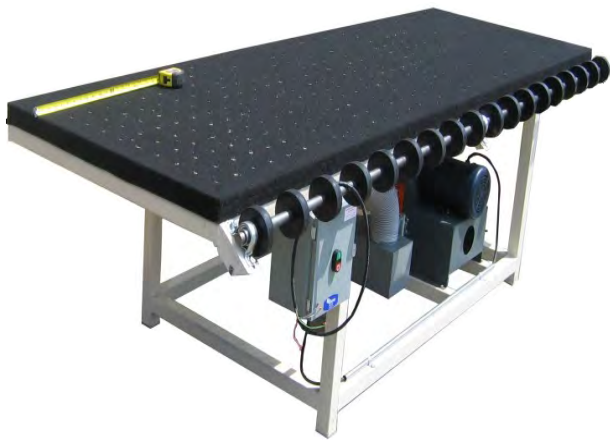

K-02LAS Laser Marking Table

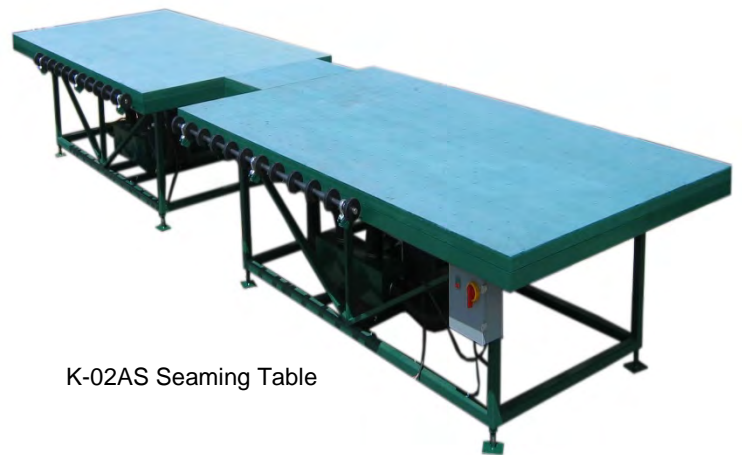

K-02AS Seaming Table



K-02FS Motorize Shop Table



K-03  
Econo- Type  
Counter- Balance

## **KEAR** Fabrication Inc.

27 Vanley Crescent, North York, Ont., Canada M3J 2B7 • Tel: (416) 398- 8666 • Fax: (416) 398-9666



K-05L  
L-Type Welded Dolly



K-04A  
Job Site Dolly



K-04L  
Job Site Dolly



K-5LP  
"L" Type Dolly



K-05A  
A-Type Welded



K-5AW Heavy Duty  
Wood Base Dolly

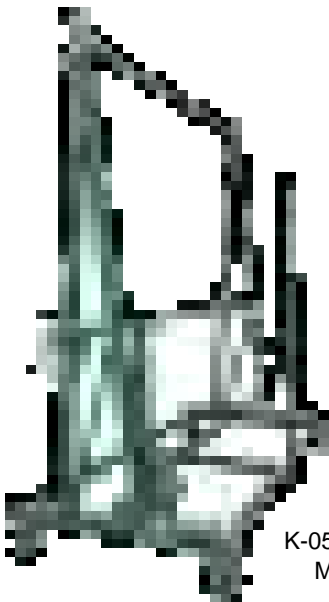

K-05L Shuttle  
Motorize Rack



K-5AWD "A" Type  
Shop Dolly



K-5AS 'A' Type Shop  
Dolly

# KEAR Fabrication Inc.

27 Vanley Crescent, North York, Ont., Canada M3J 2B7 • Tel: (416) 398- 8666 • Fax: (416) 398-9666



K-05RU  
Combination Rack 2 in 1



K-5LS 'L' Type Shop Dolly



K-5AP Heavy Duty Shop Dolly



K-05L Crate Dolly



K-06WHD Heavy Duty Shop Dolly



K-06HWD Shop Dolly



K-06SH Shipping 'A' Dolly



K-06MDW Shop Dolly



K-06WSPD 'A' Type Shipping Shop Dolly

# KEAR Fabrication Inc.

27 Vanley Crescent, North York, Ont., Canada M3J 2B7 • Tel: (416) 398- 8666 • Fax: (416) 398-9666



K-06WR  
Shop Dolly



K-06WSP  
Shop Dolly



K-06R  
Rubber Base and Sides  
Restraining Arm



K-06A Rubber  
Base and Sides



K-06P  
Plastic Base and Sides  
Floor Lock



K-06JP Jumbo 'A' Type Dolly



K-06AD Rubber  
Base and Sides



K-06W  
Wood Base and Sides



K-06 Oven Rack X

# KEAR Fabrication Inc.

27 Vanley Crescent, North York, Ont., Canada M3J 2B7 • Tel: (416) 398- 8666 • Fax: (416) 398-9666



K-06WDL "L" Type Windows & Door Dolly



K-07L L-Type Bolted



K-06EWE "A" Frame Slotted Rack



K-07A A-Type Bolted

(Wood base is Optional)



K-07B A-Type Dolly



K-07KD Bolted Contraction Dolly



K-08 A Type Shipping Rack



K-08A A-Type Shipping Rack



K-08AP A Type Shipping Rack

# KEAR Fabrication Inc.

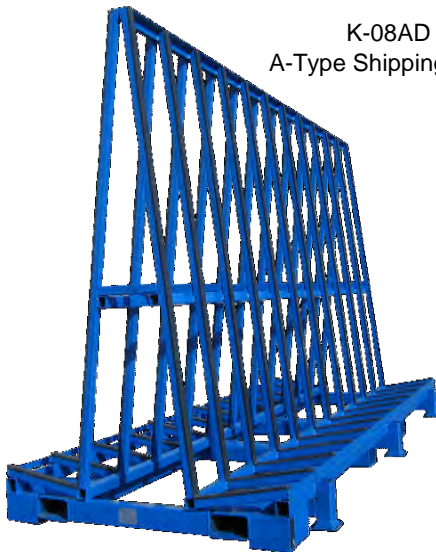

K-08AD  
A-Type Shipping Rack



K-08AER  
"A" Shipping Rack



K-08ALS  
"L" Type Shipping Rack



K-08ALD  
L- Type Stackable



K-08ALLR  
Light Duty Shipping  
Rack



K-08AW  
"A" Type Shipping Rack

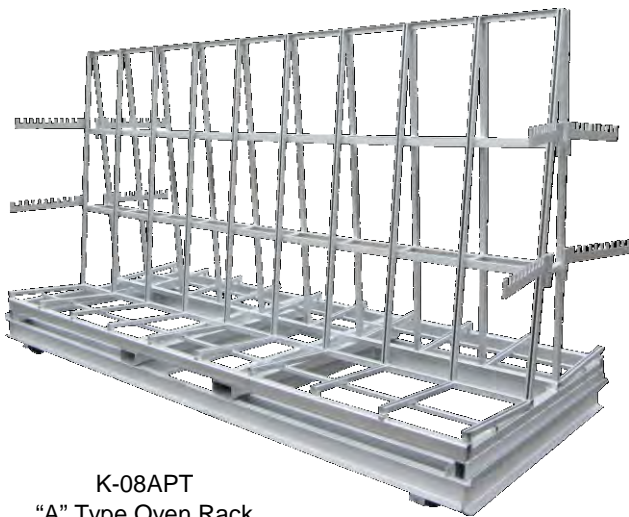

K-08APT  
"A" Type Oven Rack  
With Roll-In Base



K-08AERW 'A' Type Tow  
Rack

# KEAR Fabrication Inc.

27 Vanley Crescent, North York, Ont., Canada M3J 2B7 • Tel: (416) 398- 8666 • Fax: (416) 398-9666



K-08AE  
Econo. A Type



K-08AS  
A-Type Stackable



K-08LS  
L-Type for Shipping



K-08DB  
Shipping Rack



K-08DA  
Shipping Rack



K-08DBW  
Shipping Rack



K-08ERWS  
"A" Type Shipping Rack

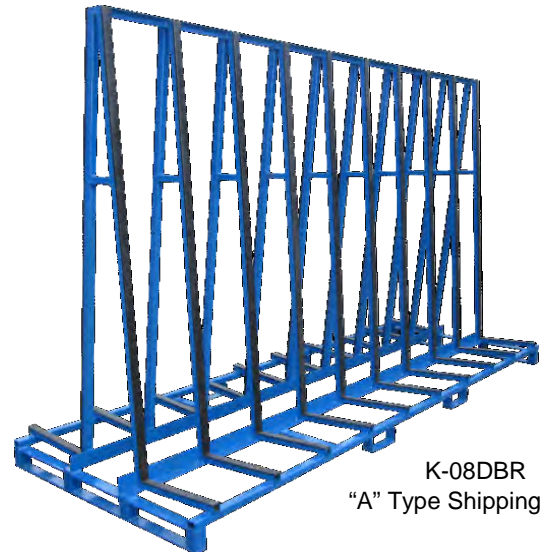

K-08DBR  
"A" Type Shipping Rack

# KEAR Fabrication Inc.

27 Vanley Crescent, North York, Ont., Canada M3J 2B7 • Tel: (416) 398- 8666 • Fax: (416) 398-9666



K-09ADSR  
Smooth Base IG Dolly



K-09A  
Harp Type IG Dolly



K-09AWO  
IG Dolly



K-09AS  
Shipping IG Cart



K-09AD  
Double Rod



K-09ADD  
IG Shipping  
Rack



K-09AER  
IG Dolly



K-09ADW  
Twin Level Sash & Frame Dolly



K-09ADD  
Twin level  
IG Dolly

# KEAR Fabrication Inc.



K-09BL  
Large IG Dolly



K-09PP  
Extra Large IG Cart



K-09AWFF  
Stackable Fully Slots IG Dolly



K-09AWST  
Stackable Shipping IG Dolly



K-09P  
IG Dolly with  
Removable Post



K-09SDL  
Full Slotted Base  
IG Dolly



K-9DDS  
IG Shipping Rack  
Stackable



K-9DLS  
IG Shipping Rack  
Stackable

# KEAR Fabrication Inc.

27 Vanley Crescent, North York, Ont., Canada M3J 2B7 • Tel: (416) 398- 8666 • Fax: (416) 398-9666



K-09DOB  
Open Base IG Dolly



K-09DOP  
Open Base IG Dolly with  
PVC Fingers



K-09D  
Standard Type  
\* PVC Fingers



K-09E  
Shipping Type



K-09B  
Shipping IG Rack



K-09DSS  
Solid HDPE Fingers



K-09D2  
IG Dolly can put 2 Type of  
IG size



K-09C  
Econo-Type  
\* Wood Fingers

# KEAR Fabrication Inc.





K-09RSF  
Full Base Heavy Duty  
IG Dolly



K-09RFB  
Full Slotted IG Dolly



K-09R  
Rod Type



K-09SI  
IG Shipping Rack



K-9SR  
For Shipping

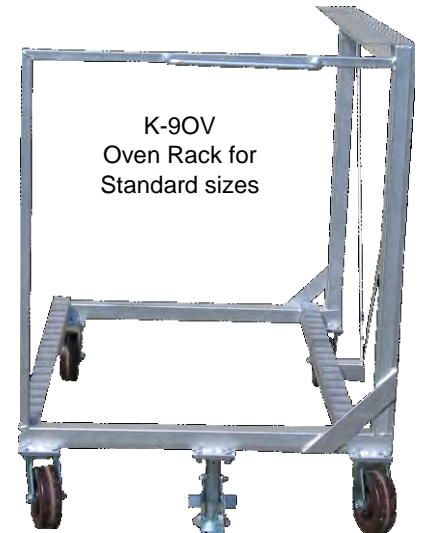

K-9OV  
Oven Rack for  
Standard sizes



K-09DEL  
Extend Leg IG Dolly



K-09SH  
Screen Harp Rack

# KEAR Fabrication Inc.

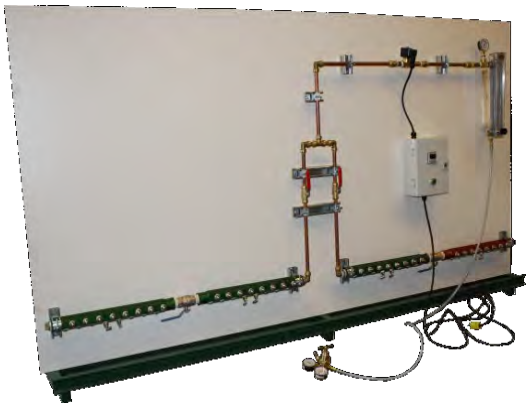

K-10SF  
Multi-Head Gases Filling station

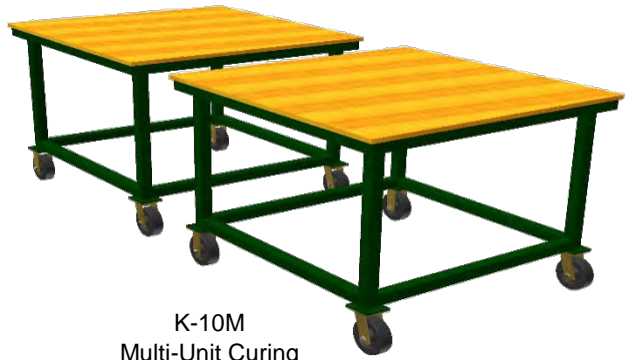

K-10M  
Multi-Unit Curing  
Table



K-10B  
Desiccant  
Filling Device



K-10ST  
Argon Gases Fill Station



K-10S  
Sunburst Table



K-10WH  
Hanging  
Rack



K-10A  
Rack Type  
Also for Spacer



K-10G  
Grill Cart



K-10AE  
Multi  
Lock  
Hang  
Dolly

# KEAR Fabrication Inc.



K-11  
File Dolly



K-11S  
Shipping Type



K-11SLR  
Custom Glass Shipping  
Rack



K-11LH  
Solar Glass Dolly



K-11 File Dolly  
Shipping Type



K-11TLG  
Large Temper Glass



K-11W  
Low E Transport Cart



K-11STR  
String Rack



K-14FL  
Aluminium Profile Dolly

# KEAR Fabrication Inc.

27 Vanley Crescent, North York, Ont., Canada M3J 2B7 • Tel: (416) 398- 8666 • Fax: (416) 398-9666



K-12GL  
"L" Type Glass Dolly

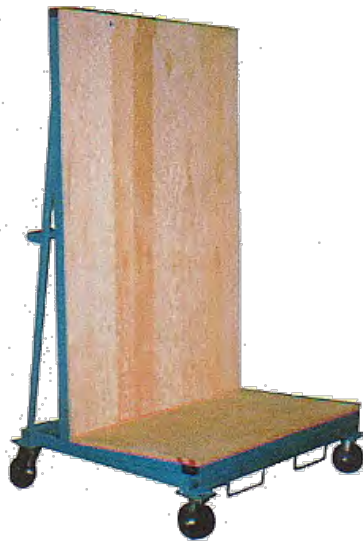

K-12  
Furniture Glass Dolly



K-13APL  
Manoeuvrable Shop Dolly



K-13A  
A-Type Manoeuvrable



K-13AWS  
Tilt Shop Dolly



K-13L  
L-Type Manoeuvrable

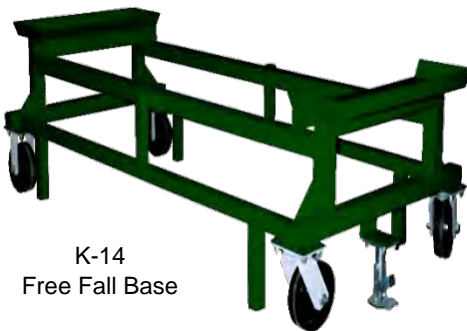

K-14  
Free Fall Base



K-14  
Optional  
Bolt on  
Rack



K-14UP Pass Thru  
Window Door Cart

# KEAR Fabrication Inc.

27 Vanley Crescent, North York, Ont., Canada M3J 2B7 • Tel: (416) 398- 8666 • Fax: (416) 398-9666



K-14A  
Window & Door Dolly  
Standard Green



K-14AR  
Window Door Cart



K-14AS  
Window Door Cart



K-14DTD  
Window Door Cart



K-14C  
Case Glass Dolly



K-14A  
For Transport Single IG



K-49 Speedy  
(Heavy Duty Dolly)



K-49 Speedy  
With Extra High

# KEAR Fabrication Inc.

27 Vanley Crescent, North York, Ont., Canada M3J 2B7 • Tel: (416) 398- 8666 • Fax: (416) 398-9666



K-15FA  
On-Fork A



K-15FB  
On-Fork B



K-15M  
Fork Lift Boom  
On-Mast

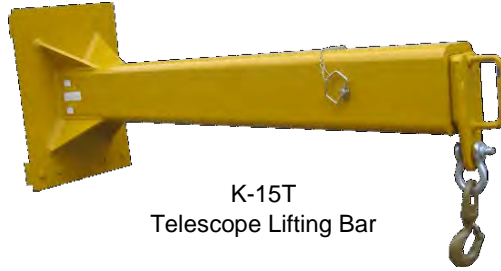

K-15T  
Telescope Lifting Bar

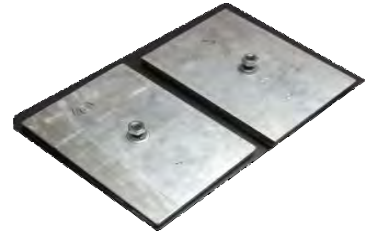

K-16SS Sling Shoes



K-16H 'H' Type Spreader Bar

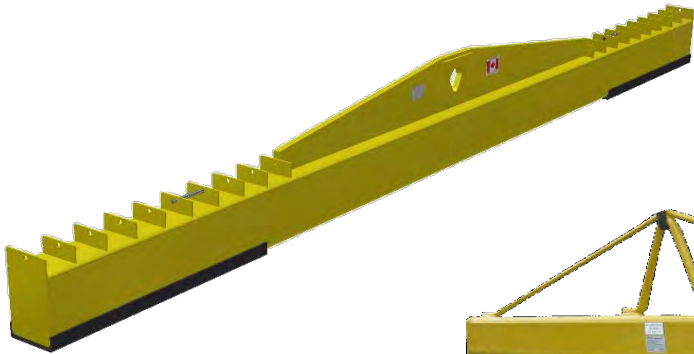

K-16 Spreader Bar



K-16CM  
Spreader Bar for Mable



K-16A  
Glass Sling

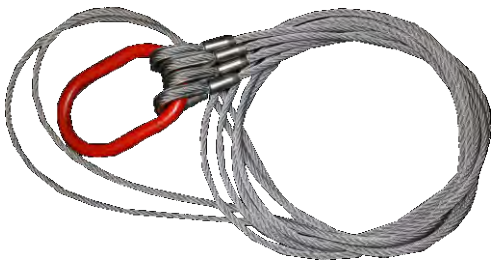

K-16C  
Cable Laid

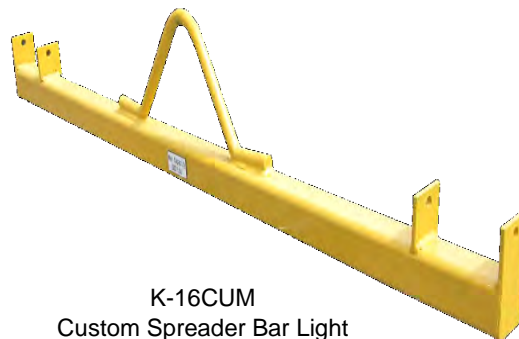

K-16CUM  
Custom Spreader Bar Light  
Duty

# KEAR Fabrication Inc.



K-17A  
Adjustable Size  
Sealing Table



K-17AR  
Sealing Table



K-17BT  
Pneumatic Tiling Caster  
Table with Manual Rotation

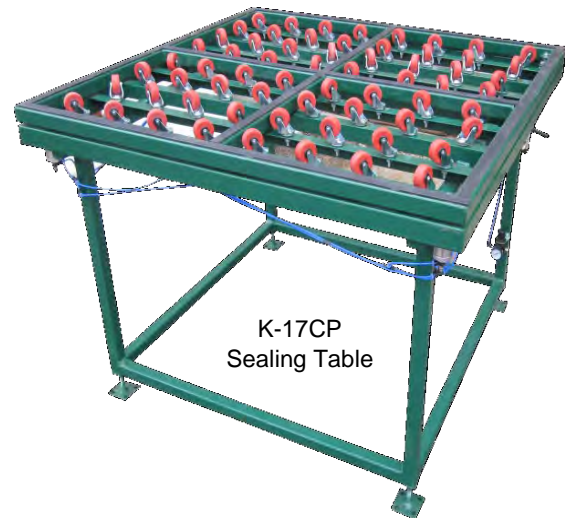

K-17CP  
Sealing Table



K-17B  
Standard Sealing Table



K-17BS  
Caster Table with Pneumatic Lift  
Suction Cup

# KEAR Fabrication Inc.

27 Vanley Crescent, North York, Ont., Canada M3J 2B7 • Tel: (416) 398- 8666 • Fax: (416) 398-9666

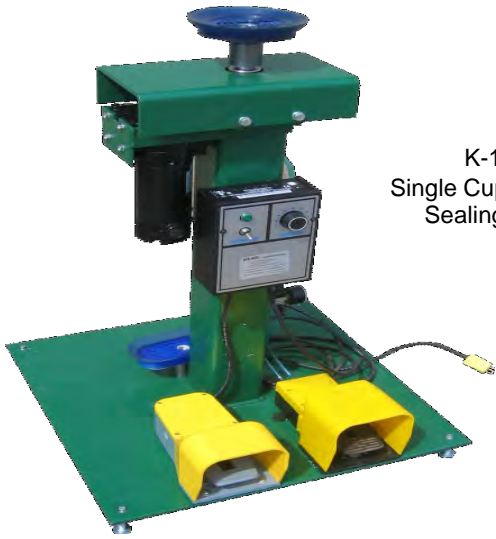

K-17S  
Single Cup Motorize  
Sealing Table



K-17E  
Single Cup with  
Expandable Support



K-17FL  
Vacuum Table



K-17W  
Swift Table



K-17BP  
Sash Assembly Table

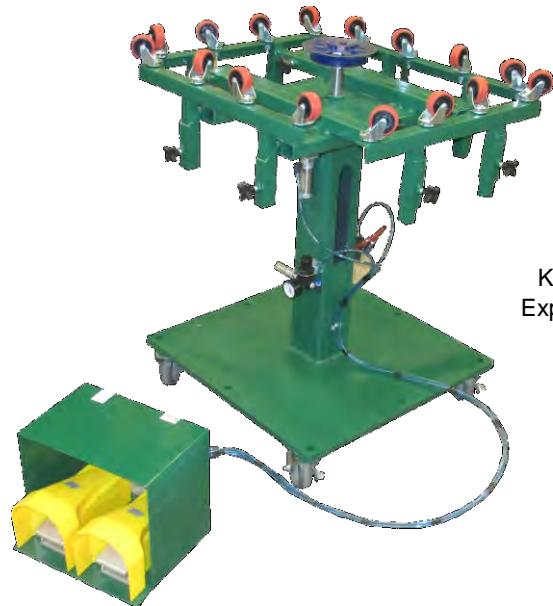

K-17BPM Mobile  
Expandable 4 Sides

# KEAR Fabrication Inc.





K-18W  
2 Levels  
Window Dolly



K-18D  
Door Dolly



K-18WIN Windows  
& Sash Dolly



K-18STV  
Door Stand for Groove Multi- lock



K-18T Tilting  
Door Dolly



K-18LT Door and Window Cart



K-18TH  
Door Shipping  
Cart (Painting Door)

# KEAR Fabrication Inc.



K-18H  
Harp Type Window Dolly



K-18HA  
Window & Sash Dolly



K-19  
Coil Dolly with Intercept Spacer



K-18WFS  
Window Dolly



K-18AS  
Door Transport Dolly



K-18DWS  
Doors & Windows Dolly

K-18DAS  
Door Pre-Assembly  
Dolly



K-18HL  
Aluminium Door Dolly

# KEAR Fabrication Inc.

K-18A  
Door Dolly



K-18FF  
Window Frame Dolly



K-18FL  
Window Frame & Sash Dolly

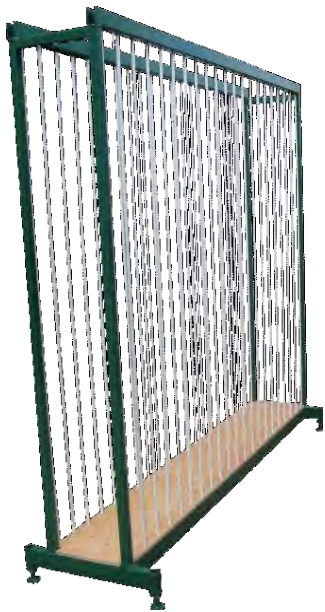

K-18U Pass Through  
Window Frame & Sash Rack



K-18AW  
Painted Window Frame Dolly



K-18UWH  
Pass Through Window Dolly



K-18UPD  
Patio Doors Dolly



K-18FU  
Door & Door Slat



K-18UL  
Cub Trolley

# KEAR Fabrication Inc.

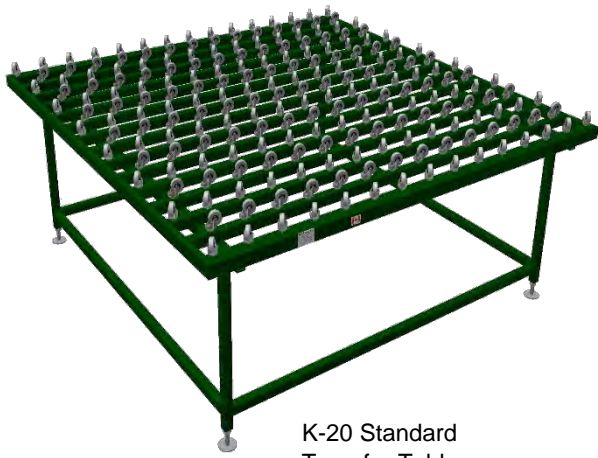

K-20 Standard Transfer Table

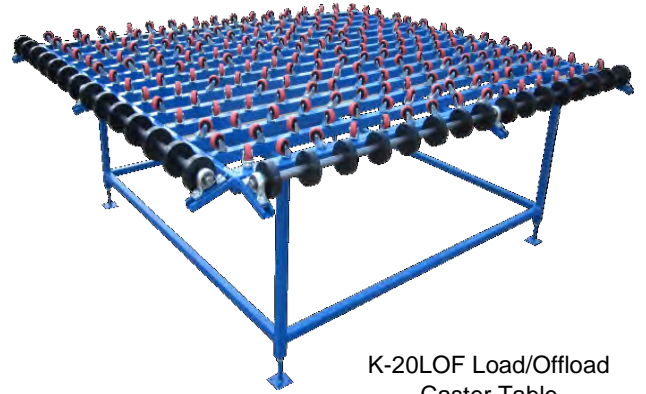

K-20LOF Load/Offload Caster Table



K-20D Drill Support Table



K-20L Load/Off Load Ball Caster Table



K-20AW Pneumatic Tilting Caster Table with Suction Cup



K-20S Seaming Table

# KEAR Fabrication Inc.

27 Vanley Crescent, North York, Ont., Canada M3J 2B7 • Tel: (416) 398- 8666 • Fax: (416) 398-9666

K-20ACM Tilt both direction Laminate Table



K-20A Tilting Type Transfer Table



K-20LG Glass Load/Off Load Table

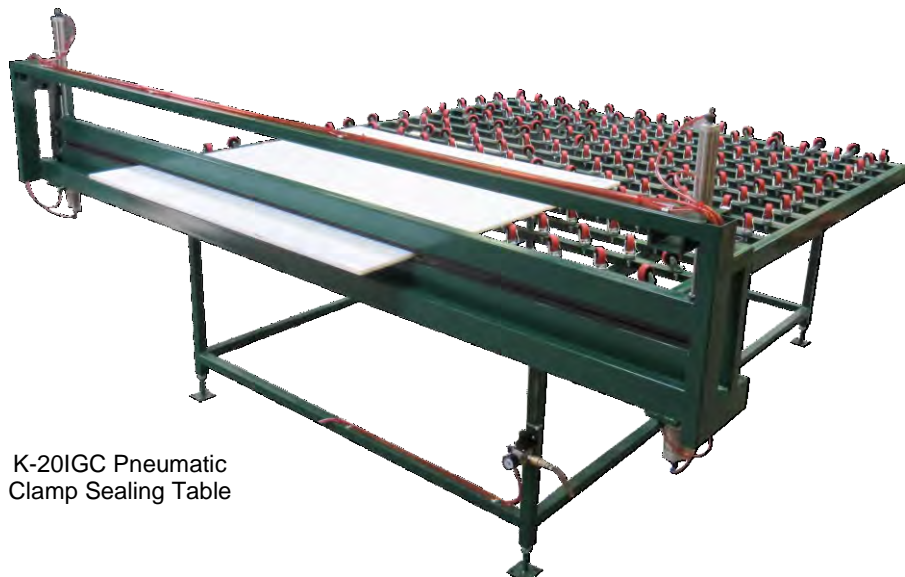

K-20IGC Pneumatic Clamp Sealing Table

# KEAR Fabrication Inc.

27 Vanley Crescent, North York, Ont., Canada M3J 2B7 • Tel: (416) 398- 8666 • Fax: (416) 398-9666

K-20IG  
IG Assembly  
Tilting Table

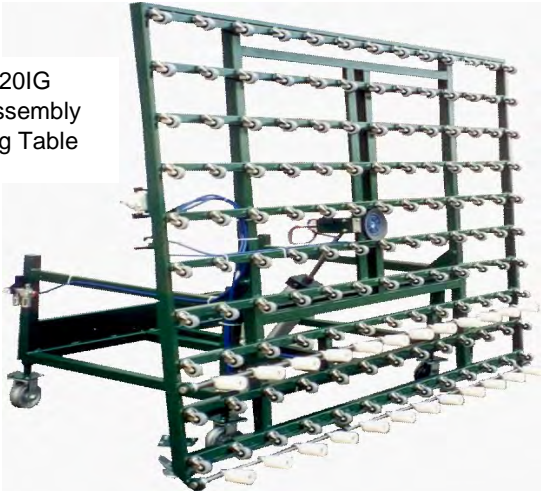

K-20AIS  
Light Inspecting Tilting  
Caster Table

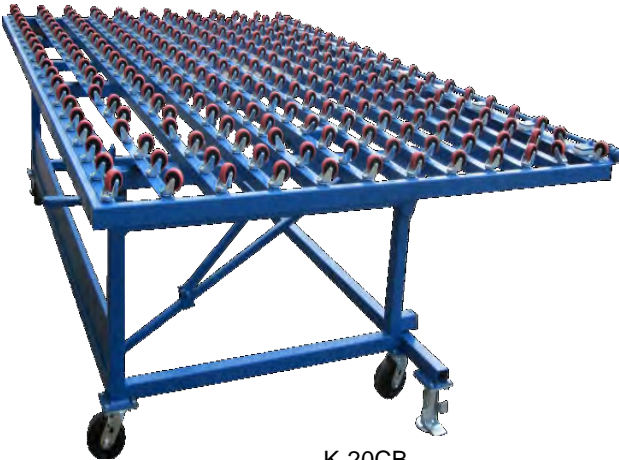

K-20CB  
Counter -Balance Transfer Table



K-20ST  
Multi -head Strip  
Cutter

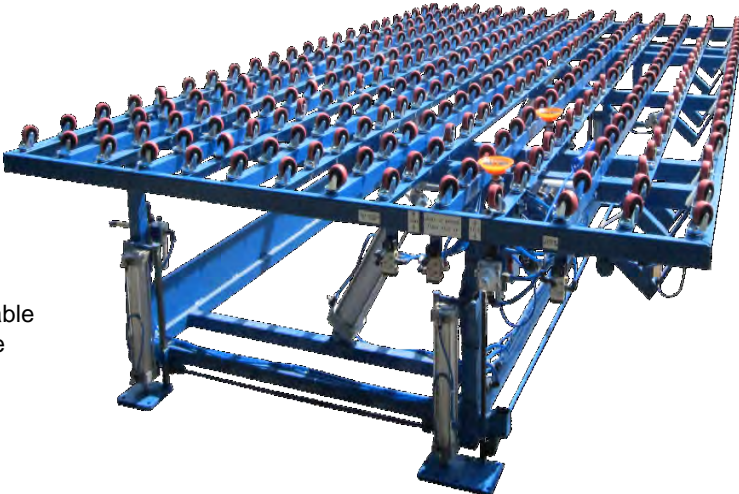

K-20ALFT  
Tilted & Lift Sealing Table  
With 2 Cups on side

**KEAR Fabrication Inc.**



K-23A  
Stackable L-Type



K-23AS  
Stackable Rack with Rubber



K-23E  
Econo L-Type



K-23PD  
Patio Doors and Shower  
Doors Stackable Rack



K-23WSP  
Window & Door Shipping Rack



K-24ZMT  
Material Transfer Dolly



K-23ULB  
Custom Rack



K-24BCK  
Stackable Basket

# KEAR Fabrication Inc.

27 Vanley Crescent, North York, Ont., Canada M3J 2B7 • Tel: (416) 398- 8666 • Fax: (416) 398-9666



K-24RA Rod Type Extrusion Dolly



K-24RL Box Type Extrusion Dolly



K-24RT Rod Type dolly

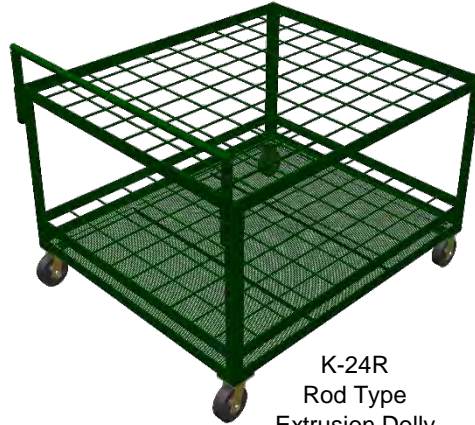

K-24R Rod Type Extrusion Dolly



K-24S Shopping Cart



K-24RMH Multi-Lock Hardware Dolly



K-24MB Box Type Extrusion Dolly



K-24TST Step Tube Type Extrusion Dolly



K-24T Tube Type Extrusion Dolly



K-24M Extrusion Dolly

# KEAR Fabrication Inc.





K-24AL  
Aluminium Extrusion Rack



K-24WH  
Window Frame Dolly



K-24H  
Window Frame Dolly



K-24P Frame Cart



K-24C  
Frame Buggy



K-24WP  
Patio Door Frame  
Storage Rack



K-24AV  
Window Dolly



K-24VS  
Patio Door  
Frame Dolly

# KEAR Fabrication Inc.



K-25RA  
With Removable  
Sides



K-25TTOF  
Cut -Off Material Dolly



K-25PD  
Patio Door Storage Rack



K-25AW  
Window Dolly



K-25A  
Tilted Type  
Window Dolly

# KEAR Fabrication Inc.



K-25W  
Cradle Type Window Dolly

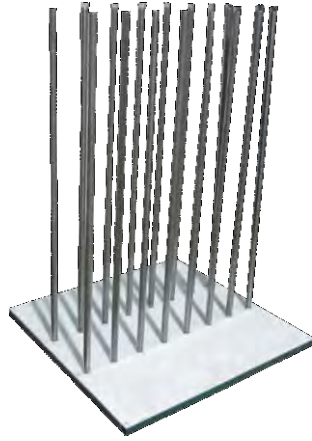

K-25PINS  
Pins Rack



K-25TT Material Dolly



K-25UHA  
Pass Thru Dolly

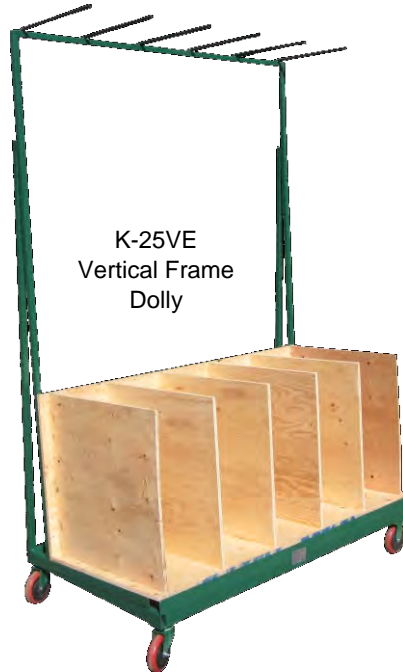

K-25VE  
Vertical Frame  
Dolly



K-25LS  
Window Shipping Dolly



K-25L  
L-Type



K-25LB  
L Dolly

# KEAR Fabrication Inc.

27 Vanley Crescent, North York, Ont., Canada M3J 2B7 • Tel: (416) 398- 8666 • Fax: (416) 398-9666



K-25BT  
Tilting-Type  
Roller Transfer Table



K-25BR  
Load and off load  
Roller Transfer



K-25BL  
Off Load Roller Table

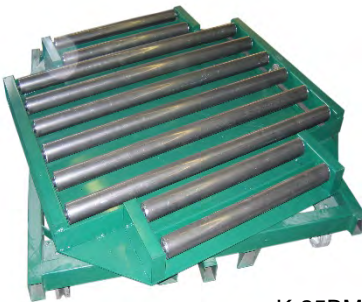

K-25BM Manual  
Rotary Table



K-25TR Load and  
offload Roller Table



K-25PTS  
Strap Packaging Table  
(Strap Window)

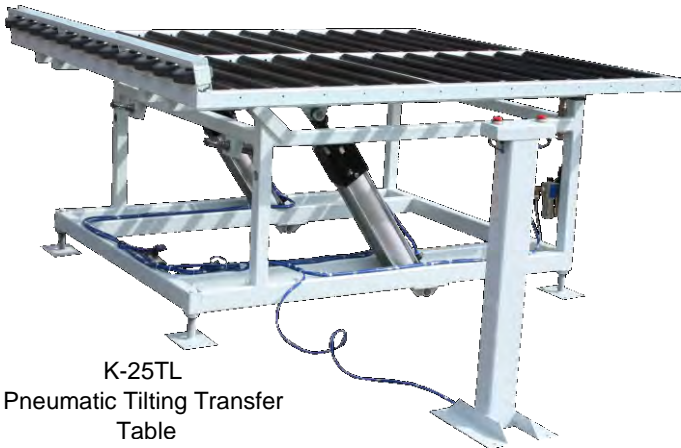

K-25TL  
Pneumatic Tilting Transfer  
Table



K-25T  
Tilt Type

# KEAR Fabrication Inc.



K-25B  
Standard Type



K-25C  
Roller Transfer Table



K-25FT  
Door Loading Table



K-25HS  
Scissor Lift Transfer  
Table



K-25HYD  
Scissor Lift Table



K-25BFR  
Roller Transfer Table



K-25BTHD  
Heavy Duty Transfer Tilting Table

# KEAR Fabrication Inc.

27 Vanley Crescent, North York, Ont., Canada M3J 2B7 • Tel: (416) 398- 8666 • Fax: (416) 398-9666



K-25PE  
Pneumatic Tilt and  
Extended Table



K-25WCTA  
Window and Door  
Assembly



K-25UPAS  
Pass Thru Window Dolly



K-25UU Windows Dolly  
with Center Divider



K-25ULTY  
Pass Thru Window Rack



K-25URU  
Divider Dolly

# KEAR Fabrication Inc.



K-25EU  
Vertical Storage Dolly



K-25ELF  
Door Material Cart



K-25EL  
L Type Window  
Frame Dolly



K-25RLA  
Window Door  
Frame Dolly



K-25EA "A" Type  
Window Frame Dolly



K-25RL  
Window  
Frame Dolly



K-25FA  
Rack-  
Type Dolly



K-25VSH  
Vertical Frame Dolly



K-25VSHB  
Custom Hardware Dolly

# KEAR Fabrication Inc.

K-26AL  
L-Type Mobile



K-26B  
L-Type  
Stationary

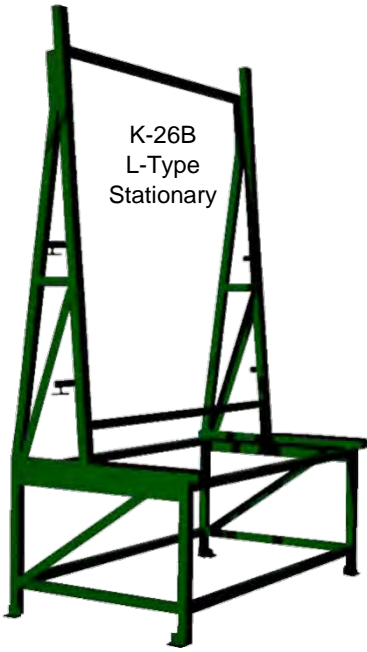

K-26S  
Swing Out  
Free Fall Rack



K-26AA  
A-Type Mobile



K-26 Window & Frame  
Dolly



K-26HYD Hydraulic Lift  
Low Headroom Free Fall



K-27ETW  
Custom Material Cart



K-27F Flat Dolly

# KEAR Fabrication Inc.





K-27TE  
Extrusion Rack



K-27E  
Extrusion Dolly



K-27EL Light Duty Extrusion  
Dolly

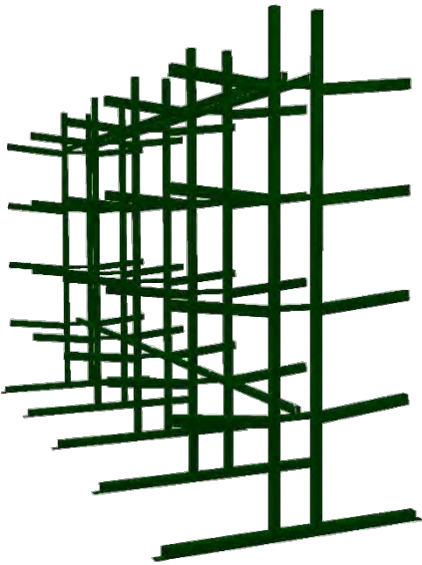

K-27A Stationary Type



K-27AS  
Extrusion Dolly



K-27VSF A Frame

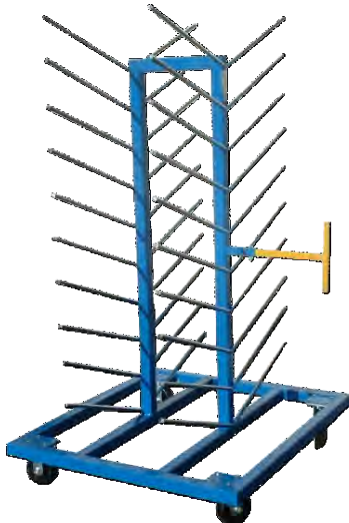

K-27BP  
Window Frame Dolly



K-27ET  
Extrusion Rack



K-27B Mobile Type

# KEAR Fabrication Inc.

27 Vanley Crescent, North York, Ont., Canada M3J 2B7 • Tel: (416) 398- 8666 • Fax: (416) 398-9666



K-27BP Multi-Level  
Extrusion Dolly

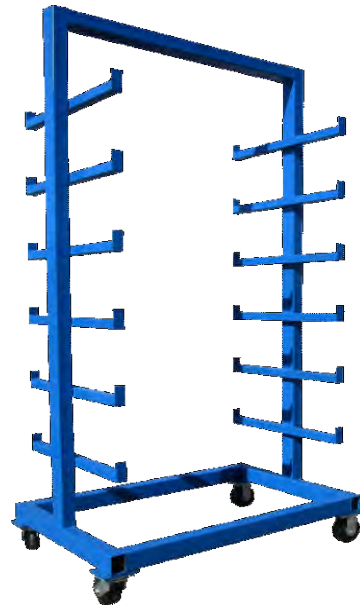

K-27EDR Extrude  
Die Rack



K-27EUL 6 Wheels 'L'  
Type Extrusion Rack

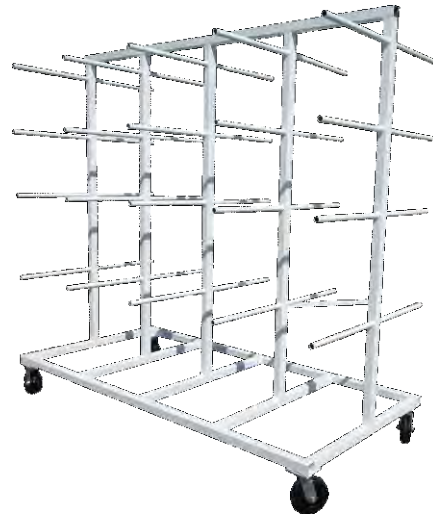

K-27TE 'T' Type  
Extrusion Dolly



K-27VDA Bolted  
Construction  
Stationary Extrusion



K-27VE 'L' Type  
Stationary Extrusion  
Rack

# KEAR Fabrication Inc.

27 Vanley Crescent, North York, Ont., Canada M3J 2B7 • Tel: (416) 398- 8666 • Fax: (416) 398-9666



K-27BW  
Window Frame Dolly

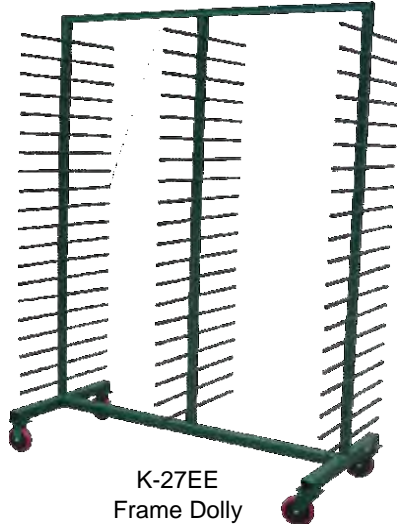

K-27EE  
Frame Dolly

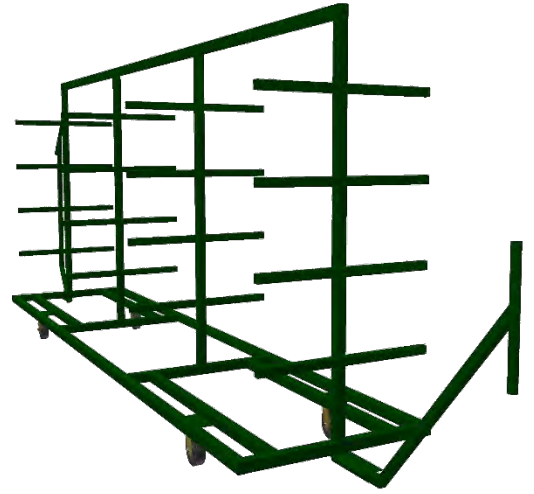

K-27 Mobile Type



K-27MOB  
Mobile Extrusion Dolly



K-27DST Door Slat Dolly



K-27TT  
Extrusion Dolly



K-27C Curing  
Dolly

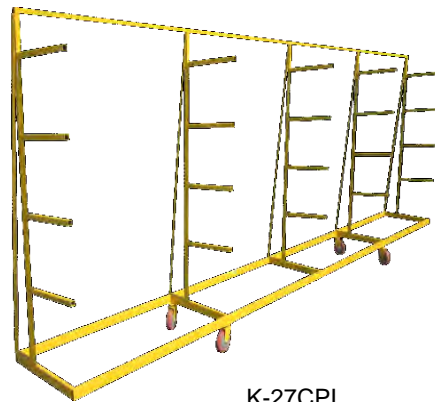

K-27CPI  
Extrusion Picking Rack



K-27AL Extrusion Dolly

# KEAR Fabrication Inc.

27 Vanley Crescent, North York, Ont., Canada M3J 2B7 • Tel: (416) 398- 8666 • Fax: (416) 398-9666



K-28CSAS  
Motorize Squaring Table



K-28MTR  
Clamping Table with Pneumatic  
Tilt, Lift and Manual Rotation

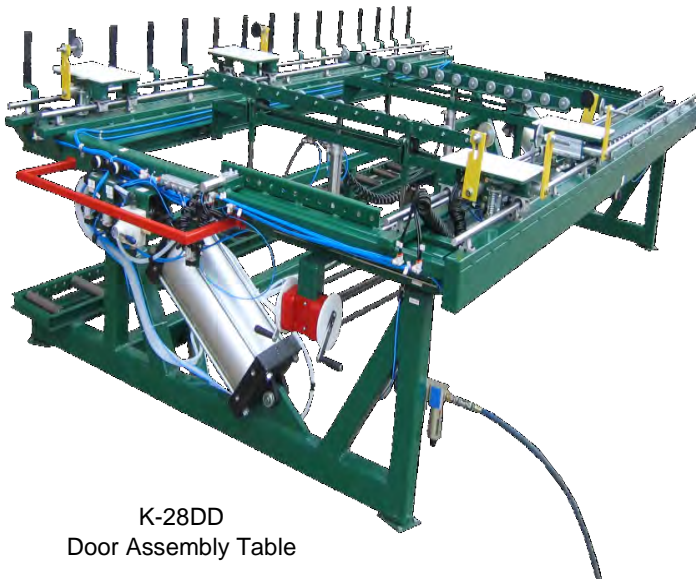

K-28DD  
Door Assembly Table

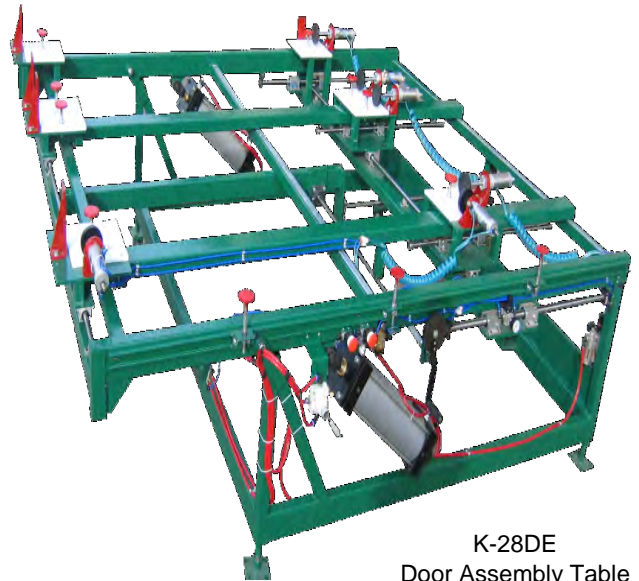

K-28DE  
Door Assembly Table

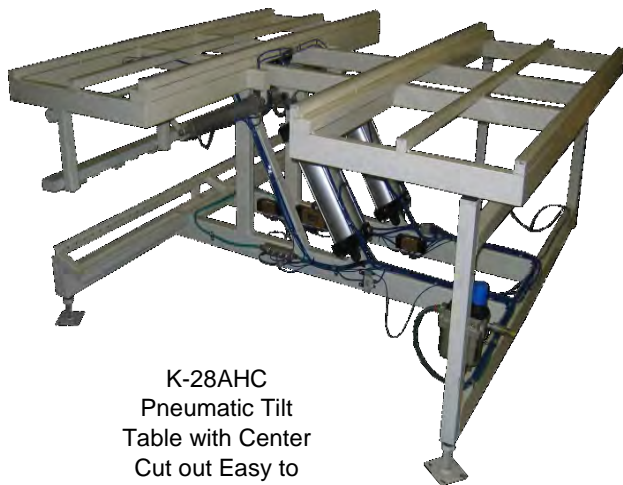

K-28AHC  
Pneumatic Tilt  
Table with Center  
Cut out Easy to  
excess

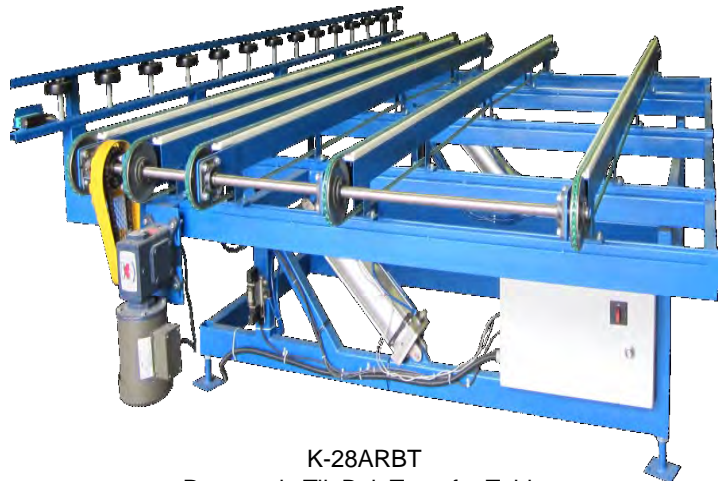

K-28ARBT  
Pneumatic Tilt Belt Transfer Table

# KEAR Fabrication Inc.



K-28A Glazing Table

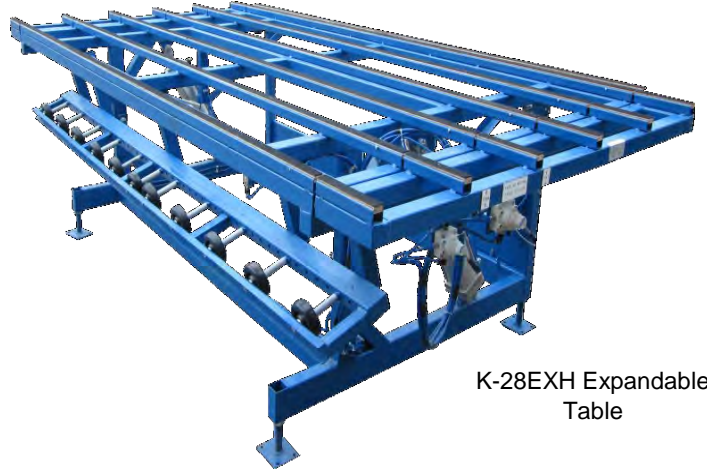

K-28EXH Expandable Table



K-28EXT Work Table with Pneumatic Tilt, Lift and Pull Out High



K-28AC Pneumatic Tilt Assembly Table with Custom Rollers for Nail Fin



K-28AFIX Fix Roller Ledge



K-28AE Pneumatic Tilting With Expandable



K-28AED Pneumatic Tilting With Expandable 4 Sides

# KEAR Fabrication Inc.

27 Vanley Crescent, North York, Ont., Canada M3J 2B7 • Tel: (416) 398- 8666 • Fax: (416) 398-9666



K-28PAW  
Pneumatic Tilt Packaging Table



K-28AH Custom  
Pneumatic  
Tilt Table



K-28HDP Solid HDPE Top



K-28HTP  
Pneumatic Tilting Table  
with Solid HDPE Top



K-28RD  
Pneumatic Tilting Rotated Table



K-28T  
Transport Table



K-28PD  
Patio Door Working Table

# KEAR Fabrication Inc.

27 Vanley Crescent, North York, Ont., Canada M3J 2B7 • Tel: (416) 398- 8666 • Fax: (416) 398-9666



K-28R  
Roller Transport Conveyor



K-28BA  
A Type Glazing Rack



K-28BMR Motorize  
Conveyor



K-28TOFF  
Pneumatic Tilting Load & Off  
Load Transfer Table

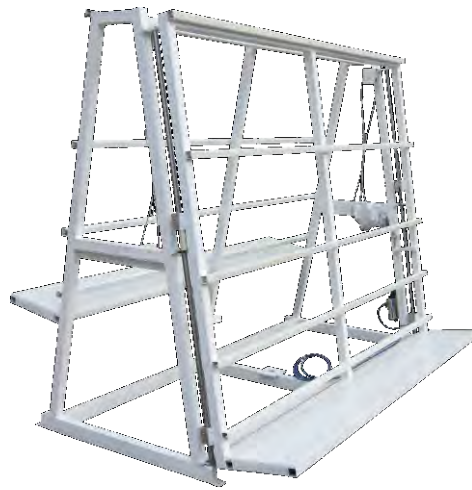

K-28BLAL  
Double Side Glazing Rack



K-28ROTB  
Rotate Transfer Conveyor



K-28AL  
Pneumatic Tilt  
Working Table



K-28AR  
Pneumatic Tilting  
Retractable Ledge



K-28B Vertical  
Assembly Conveyor

# KEAR Fabrication Inc.

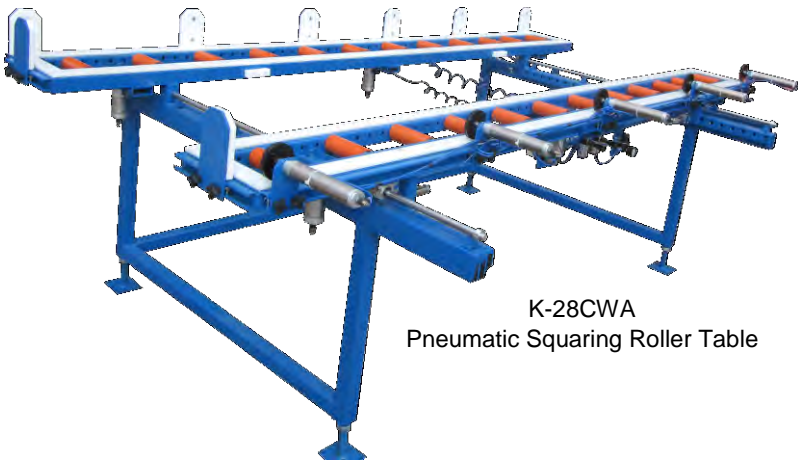

K-28CWA  
Pneumatic Squaring Roller Table



K-28CW Curtain Wall Assembly Table



K-28AP  
Pneumatic Tilt  
Transport Table

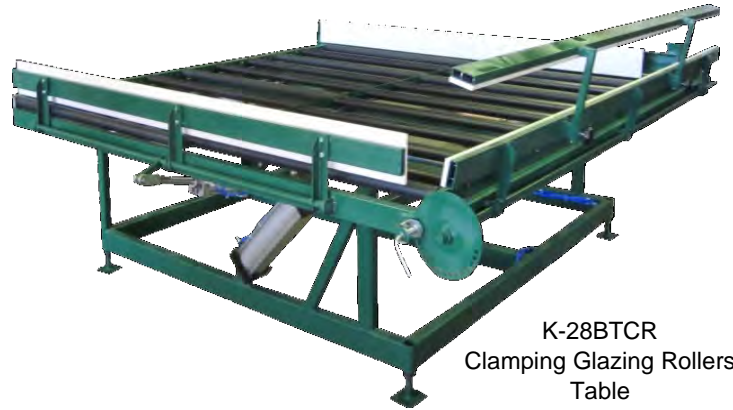

K-28BTCR  
Clamping Glazing Rollers  
Table



K-28BLS  
Vertical Assembly  
Rack



K-28  
Assembly Table



K-28AS  
Pneumatic Tilting  
Table with Slap  
Support

# KEAR Fabrication Inc.

27 Vanley Crescent, North York, Ont., Canada M3J 2B7 • Tel: (416) 398- 8666 • Fax: (416) 398-9666



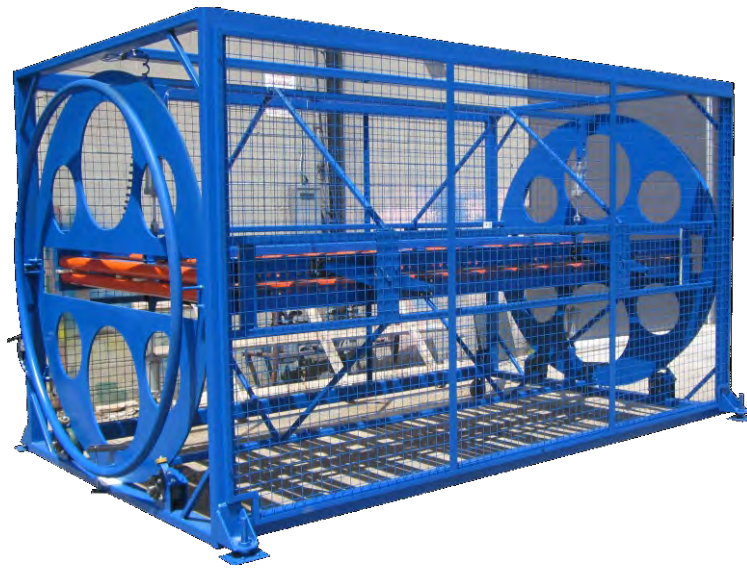

K-28RRTM  
Motorize Rotate Conveyor



K-28TEC  
Multi-Fashion Table

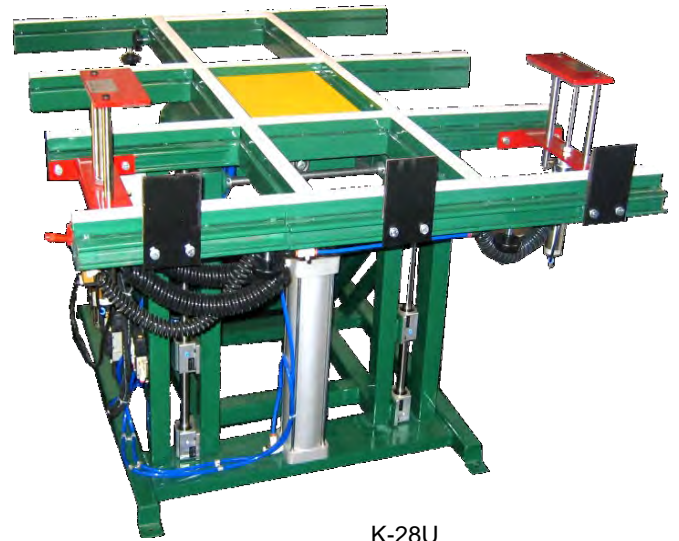

K-28U  
Working Table for  
Assembly Aluminums  
Windows



K-28DAT Door & Sidelights  
Assembly Table



K-28DATS  
Door Clamp Squaring  
Table

# KEAR Fabrication Inc.

27 Vanley Crescent, North York, Ont., Canada M3J 2B7 • Tel: (416) 398- 8666 • Fax: (416) 398-9666



K-28BIN  
Inspected Light Conveyor



K-28ESVI  
Enclosed Inspected Light Table



K-28SW Swing Conveyor



K-28ISS  
Inspection Station



K-28DA Door Assembly Table

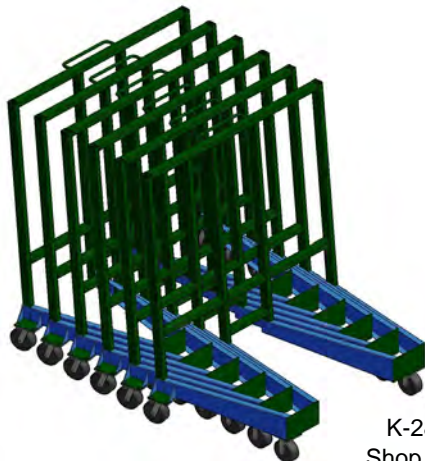

K-28S  
Shop Cart

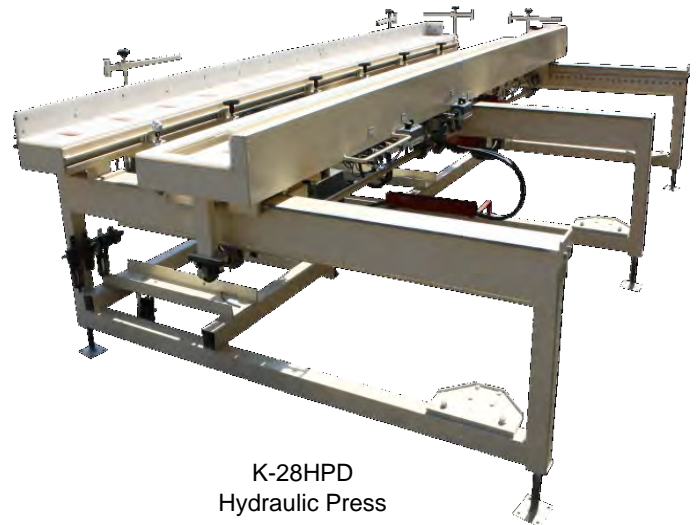

K-28HPD  
Hydraulic Press

# KEAR Fabrication Inc.

27 Vanley Crescent, North York, Ont., Canada M3J 2B7 • Tel: (416) 398- 8666 • Fax: (416) 398-9666



K-28ISSR IG Inspection Station



K-28EXH-E Expandable Tilt Table

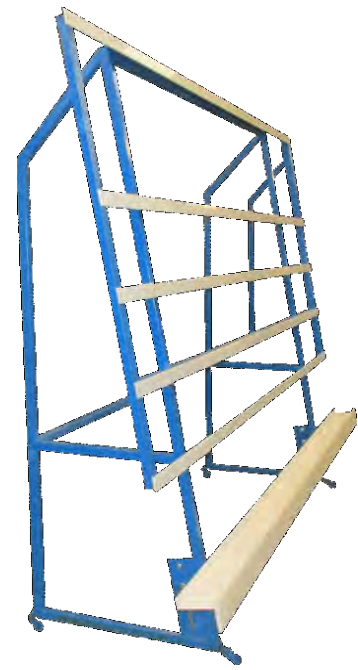

K-28B-ADL Assembly Conveyor with Adjustable



K-28ROLC Pneumatic Tilt Clamp Table



K-28PP-H Hydraulic Tilt, Clamp Table

# KEAR Fabrication Inc.

27 Vanley Crescent, North York, Ont., Canada M3J 2B7 • Tel: (416) 398- 8666 • Fax: (416) 398-9666



K-29B  
Econo-Type  
Working Table



K-29C  
Rotating  
Working Table



K-29WB  
Working Table

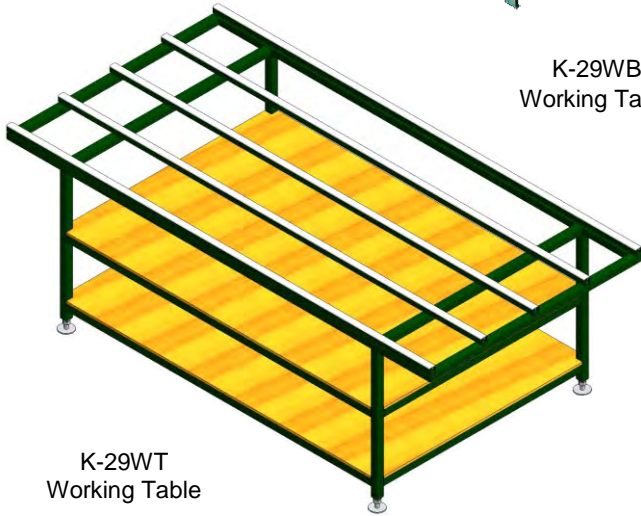

K-29WT  
Working Table



K-29WTH  
Working Table



K-29TC  
Support Table for  
CNC  
Corner Cleaner



K-29WTB  
Working Table  
with the Brush  
Top



K-29WP  
Frame Assembly  
Table

# KEAR Fabrication Inc.



K-29AT  
Pneumatic Tilting & Clamp  
Door Assembly Table

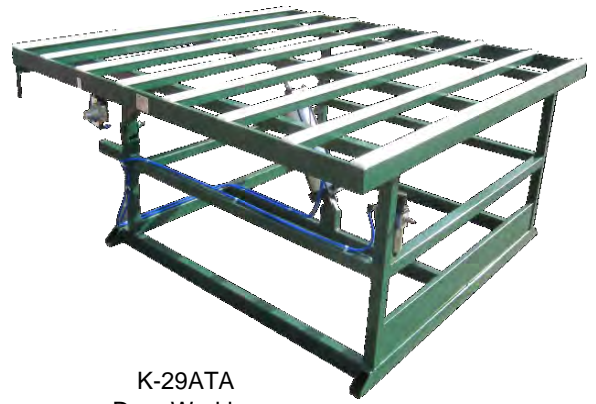

K-29ATA  
Door Working

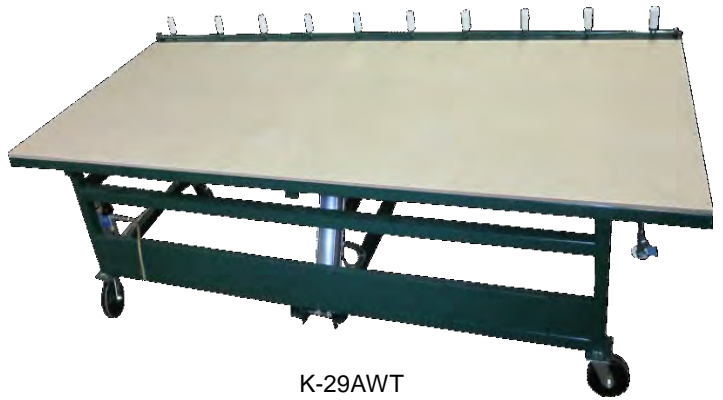

K-29AWT  
Wood Top Pneumatic Tilting Table



K-29GR Grill  
Assembly Table



K-29WCP Expandable  
Work Table

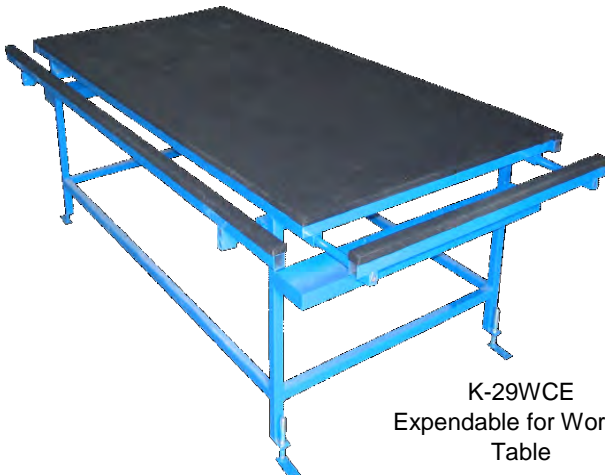

K-29WCE  
Expendable for Working  
Table



K-29RT  
Rotating Working Table

# KEAR Fabrication Inc.



K-29DR Pneumatic Tilt & Center Pop Up and Manual Rotate Table



K-29DL  
Pneumatic  
Tilting Table

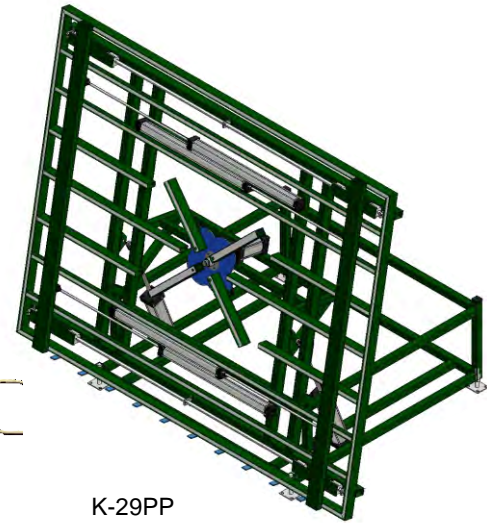

K-29PP  
Pneumatic Press  
Patio Door Sash



K-29RWM  
Ring Automatic  
Wrapping Machine

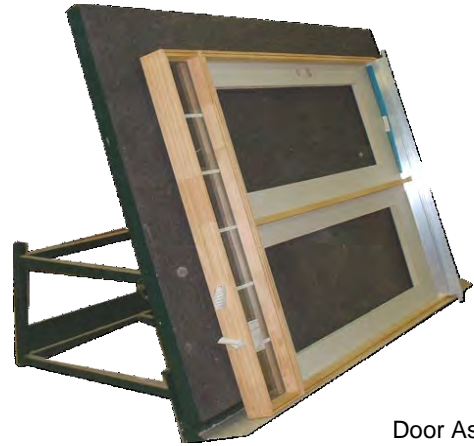

K-29D  
Door Assembly Table  
Pneumatic Retractable  
Ledge



K-29P  
Stretch Wrap Machine  
\* For Pneumatic Feeding &  
Pneumatic Control Wrap



K-29M \* For Motorized  
Feeding & Motorized  
Control Wrap

# KEAR Fabrication Inc.



K-29SPH  
Shutter Working Table



K-29WC  
Working Table with  
Carpet Top



K-29WEP  
Multi -Pull out Table



K-29WTE  
Working Table with Pull  
out Two Sides



K-29WCW  
Mobile Working Table



K-29WR  
Working Table



K-29WDH  
Door Hardware Working Table



K-29WCHR  
Hardware Working Table

# KEAR Fabrication Inc.



K-30ES  
For Shipping



K-30E  
Econo-Type



K-30A  
Standard Storing Rack



K-30ER  
Stackable Extrusion Rack

# KEAR Fabrication Inc.

27 Vanley Crescent, North York, Ont., Canada M3J 2B7 • Tel: (416) 398- 8666 • Fax: (416) 398-9666





K-32TT  
Trackless Type  
Table Height

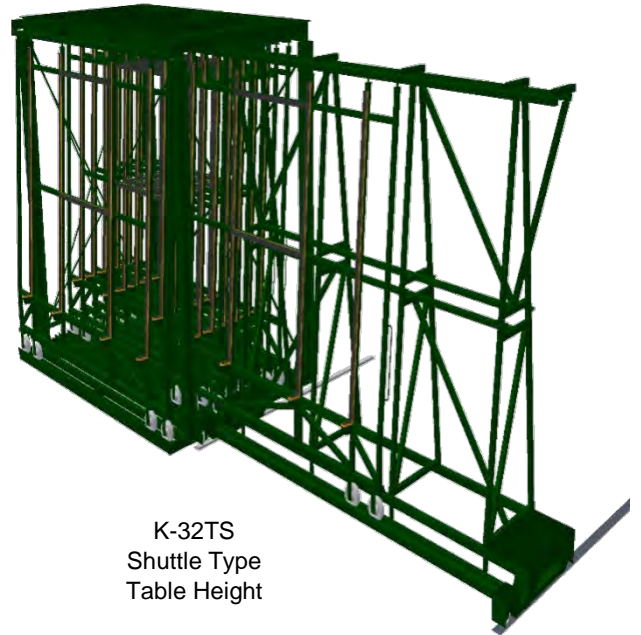

K-32TS  
Shuttle Type  
Table Height

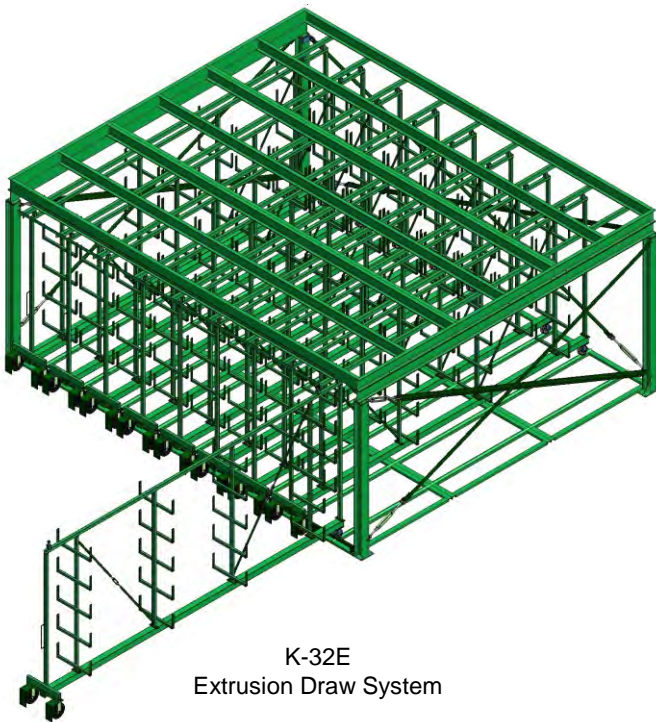

K-32E  
Extrusion Draw System



K-32F  
Trackless Type  
Floor Height

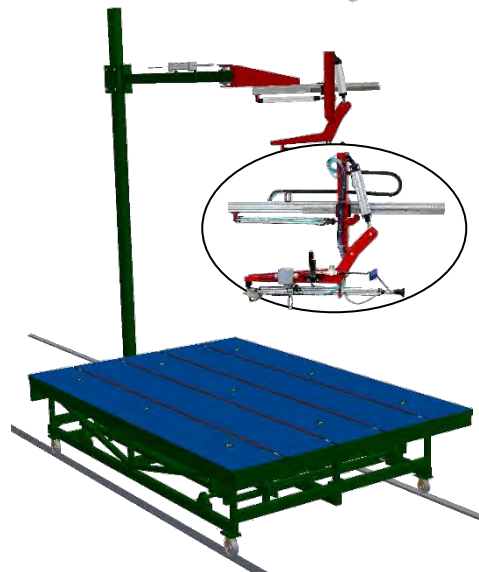

K-02S  
Shopping Table

# KEAR Fabrication Inc.

27 Vanley Crescent, North York, Ont., Canada M3J 2B7 • Tel: (416) 398- 8666 • Fax: (416) 398-9666

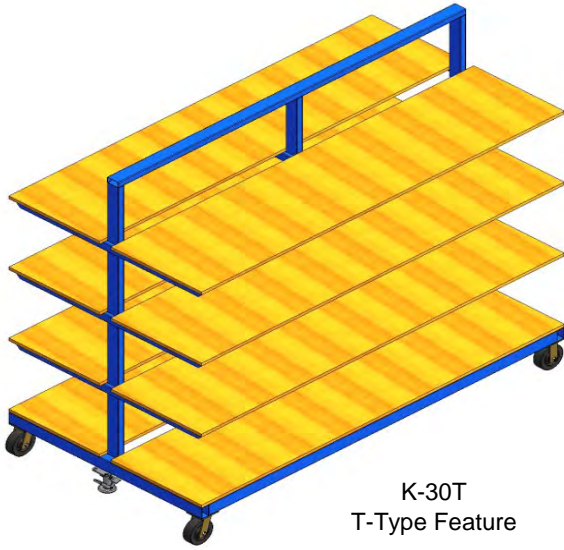

K-30T  
T-Type Feature



K-30S Shelf Type Feature

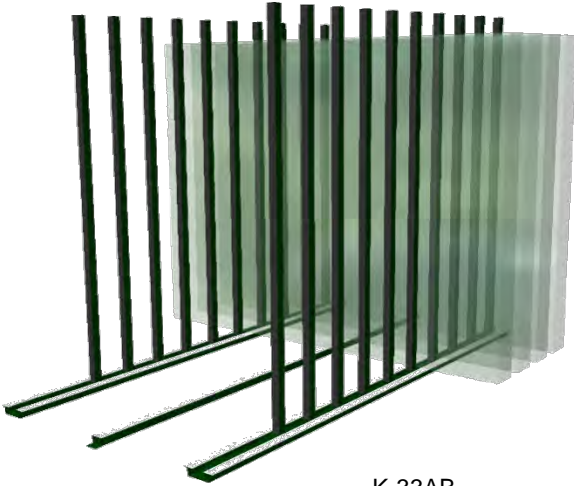

K-33AB  
Adjustable Block Type

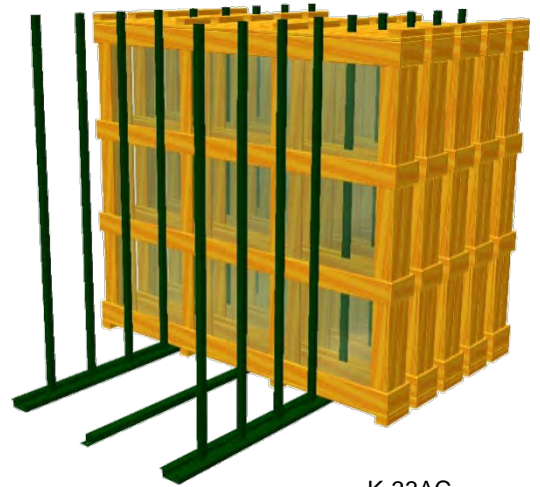

K-33AC  
Adjustable Case-Type



K-33JG Jumbo Glass Rack  
Bolted Construction



K-33JGA  
Jumbo Glass Bolted

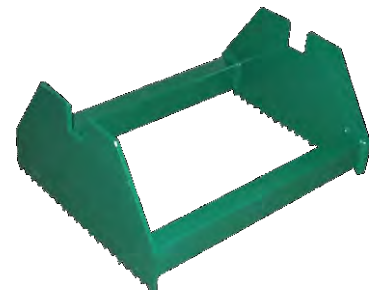

K-30ST  
Loading Lock

# KEAR Fabrication Inc.

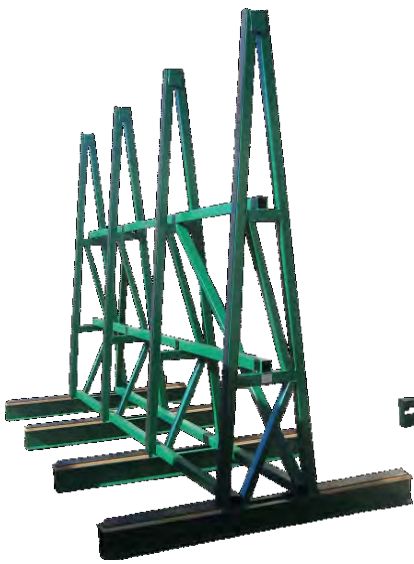

K-33J  
Jumbo Rack



K-33DA  
"A" Type Glass Block Truck



K-33D  
Double Sided  
Truck Rack



K-33LST  
"L" Type Storage



K-33L  
L-Type



K-33A  
A-Type



K-34AL  
Casement Type  
Lifting Frame

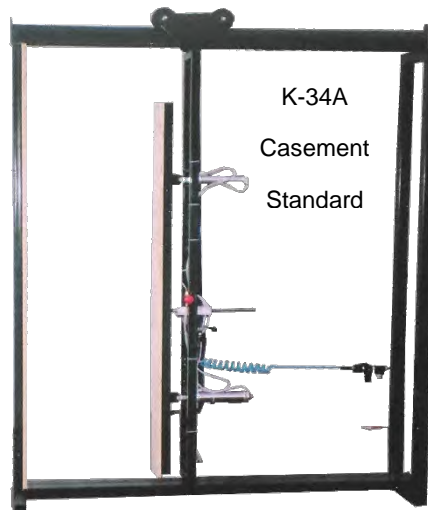

K-34A  
Casement  
Standard



K-34SR Glazing and  
Squaring Rack

# KEAR Fabrication Inc.



K-34P  
Patio Door Type  
Oversize, Spreader Device



K-34G  
Assembly & Glazing Rack  
with Pneumatic Clamp



K-34L  
Pneumatic Lift



K-34LF  
Pneumatic Lift  
Glazing Rack



K-34RDD  
Double Glazing Rack with  
Retractable Clamp and Custom  
Rollers for Nail Fin



K-34S  
Standard



K-34R  
Retractable Members



K-34AP 'A' Type



K-34SS  
Sash Type  
\*High Working Height

# KEAR Fabrication Inc.

27 Vanley Crescent, North York, Ont., Canada M3J 2B7 • Tel: (416) 398- 8666 • Fax: (416) 398-9666

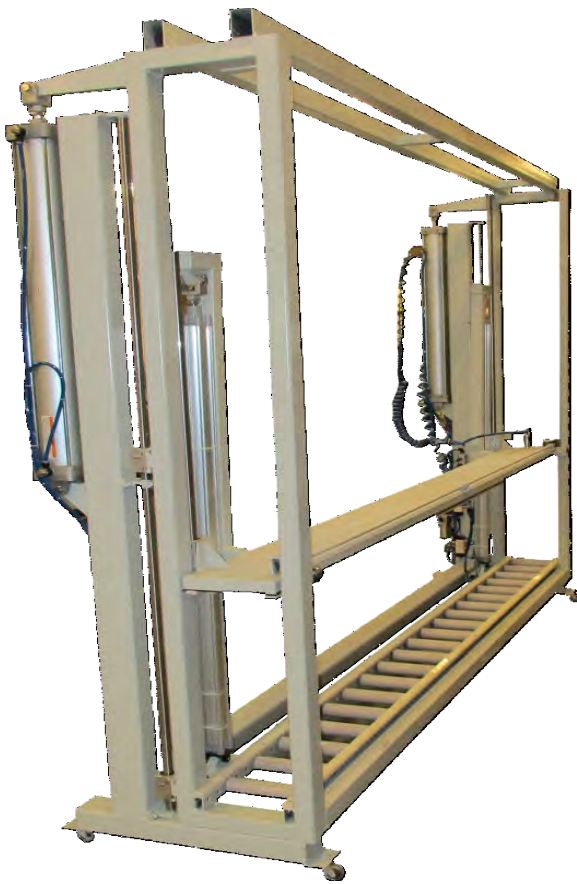

K-34ALG Pneumatic Lift,  
Top Clamp Pass-Thru  
Glazing Rack



K-34DCS Pneumatic Lift,  
Top Clamp Pass-Thru  
Glazing Rack



K-34PTH  
Pass-Thru Door window  
Glazing & Squaring Rack



K-34RT Pneumatic  
Clamp, Lift, Tilt Square  
& Glazing Rack

# KEAR Fabrication Inc.

27 Vanley Crescent, North York, Ont., Canada M3J 2B7 • Tel: (416) 398- 8666 • Fax: (416) 398-9666

K-34ALRC Retractable  
Glazing & Squaring Rack

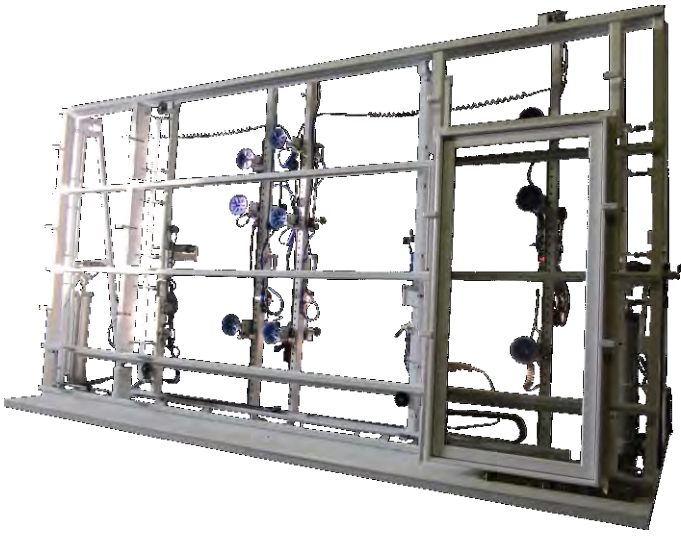

K-34AGG  
Glazing & Squaring Rack  
for Aluminum Doors and  
Windows

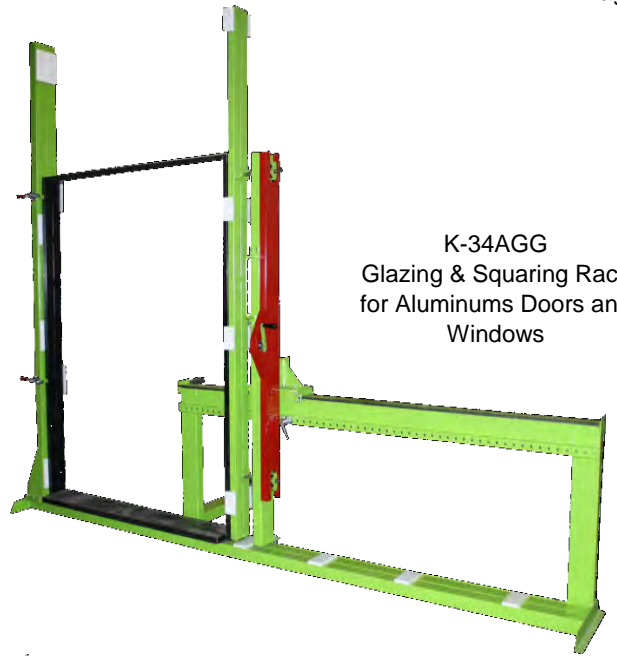

K-34DP Door Clamp  
(Open/Install Hardware)



K-34AOG  
Jumbo Glazing  
& Squaring Rack



K-34DPA  
Door Press Assembly Rack



K-34LFEX Roller Back  
Pneumatic Lift Glazing  
Rack

# KEAR Fabrication Inc.



K-35WP Window Packaging



K-35 Powered Conveyors

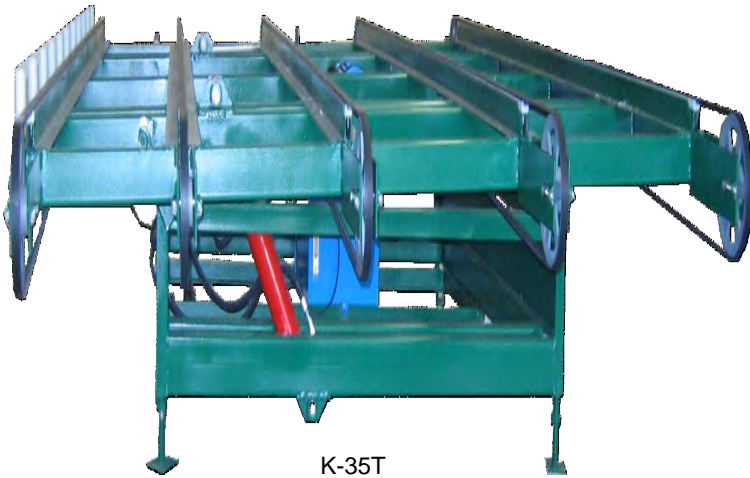

K-35T Tilting Conveyor Table



K-35ROT Automatic Rotate Index Free fall 3 Station



K-35B Powered Conveyor



# KEAR Fabrication Inc.

27 Vanley Crescent, North York, Ont., Canada M3J 2B7 • Tel: (416) 398- 8666 • Fax: (416) 398-9666



**K- 36**  
**Automatic Rotation**  
- Suitable for Window Assembly Line



**K-37VL**  
Vertical L-Type



**K-37GA**  
Grid Assembly  
Table

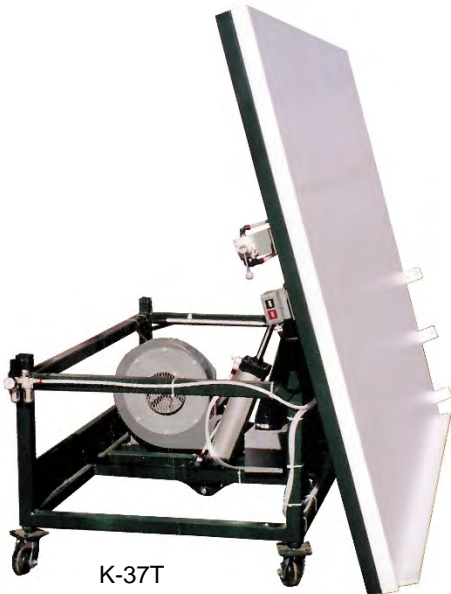

**K-37T**  
Table Type  
Grid Table



**K-37VA**  
Vertical A-Type



**K-37C**  
Air Float Grid Table with Corner Squaring



**K-37GT** Grill  
Assembly Table with  
Pneumatic Tilt and  
Pop up Ledge

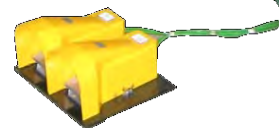

# **KEAR** Fabrication Inc.

27 Vanley Crescent, North York, Ont., Canada M3J 2B7 • Tel: (416) 398- 8666 • Fax: (416) 398-9666



K-38 Screen Table



K-38M Manual Screen Table

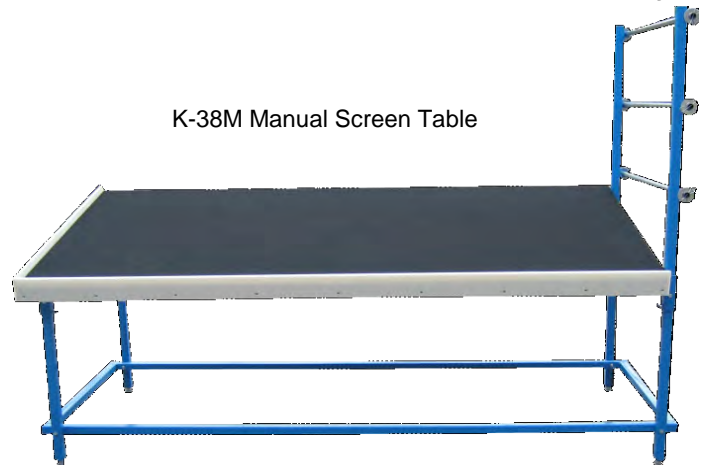

K-38MTR Screen Table  
With Tilt Any Degree



K-39RR  
Reeling Cart with  
4 Holding Reel

K-39RR  
Reeling Cart With  
2 Holding Reel

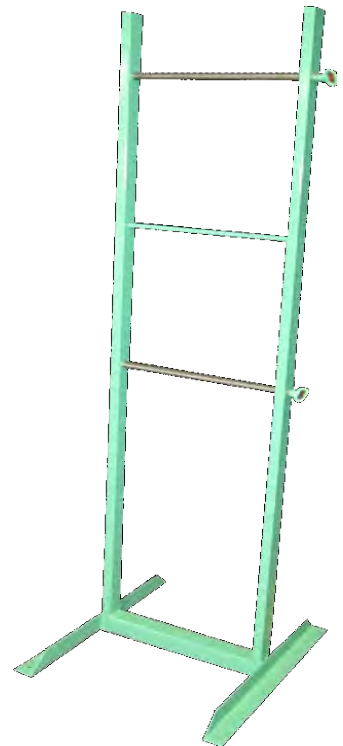
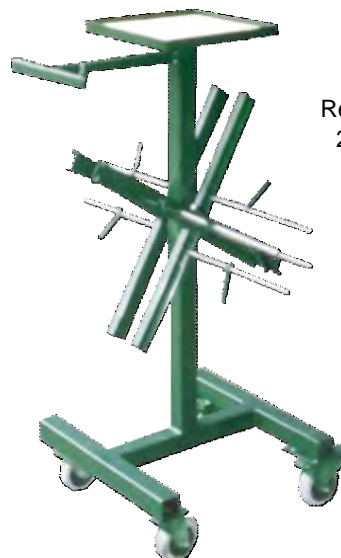

K-39STY Pool Stand

# KEAR Fabrication Inc.

27 Vanley Crescent, North York, Ont., Canada M3J 2B7 • Tel: (416) 398- 8666 • Fax: (416) 398-9666



K-40  
Edge Deletion Table



K-40A  
Semi-Automatic  
Edge Deletion Table

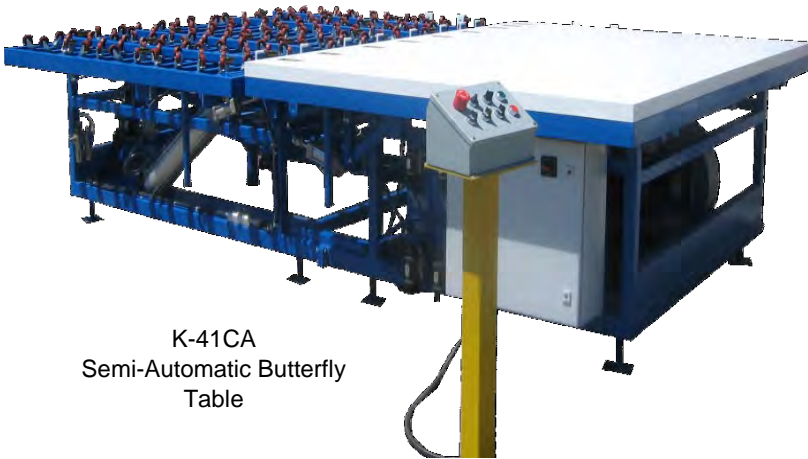

K-41CA  
Semi-Automatic Butterfly  
Table



K-41 Butterfly Table



K-41DFL  
Door Flip Transfer Table



K-41VDT Flip Table

# KEAR Fabrication Inc.

27 Vanley Crescent, North York, Ont., Canada M3J 2B7 • Tel: (416) 398- 8666 • Fax: (416) 398-9666



K-42 Spacer Printing



K-43 Linear Wrapping Machine

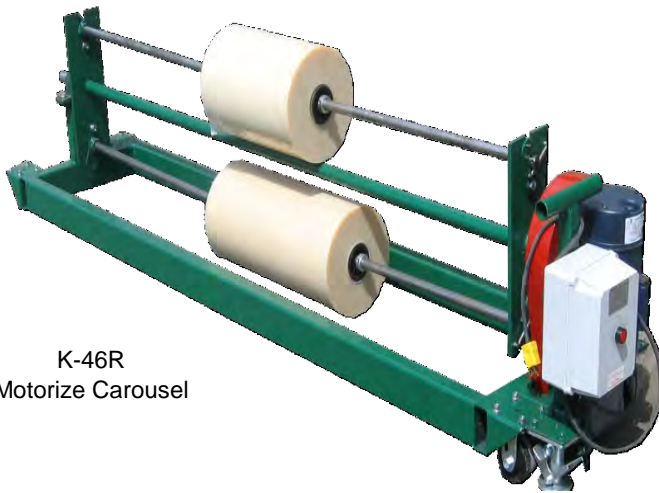

K-46R Motorize Carousel



K-46MCR Motorize Carousel



K-46FA Firm Application for Protection Glass



K-46H Heat Roller Press

# KEAR Fabrication Inc.

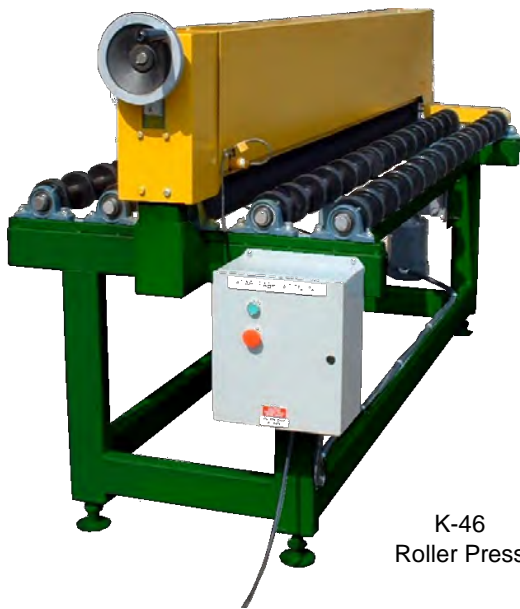

K-46  
Roller Press



K-46P Roller Press  
Protection Backing Mirror



K-47C  
Application Table  
With Caster Top



K-47MI  
Small Glass Application  
Table with Pneumatic  
Tilt



K-47AM  
Manual Application  
Table



K-47S Swiggle  
Ribbon Collector

# KEAR Fabrication Inc.



K-51  
Patio Door Turning  
Device



K-50  
Hydraulic Door Press



K-47A  
Application Table



K-47H  
Spoon Holding Stand



K-52  
Georgian Grill  
Notch Machine



K-47F  
Flexible Spacer  
Spool Holder



K-47OCT  
Octagonal Swigged Table

# KEAR Fabrication Inc.

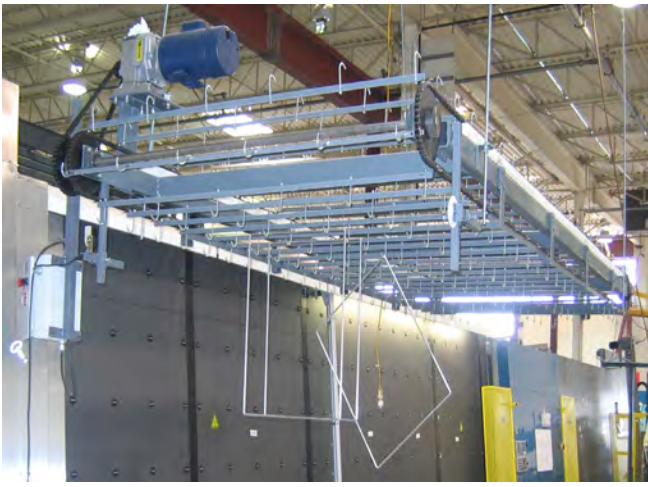

K-53  
Overhead Spacer  
Conveyor



K-53W  
Overhead Window  
Conveyor



K-55  
Seal Press Machine

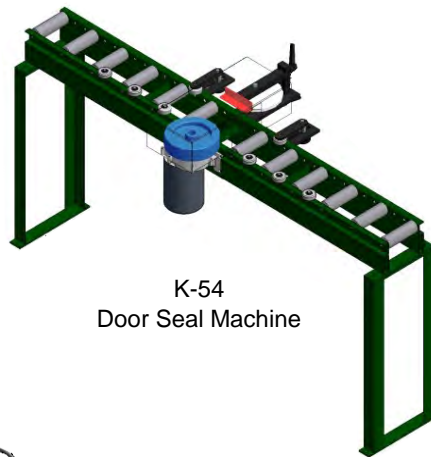

K-54  
Door Seal Machine



K-57 PVC Profile Lifting  
Punch Station



K-58  
Door Flap Working  
Station

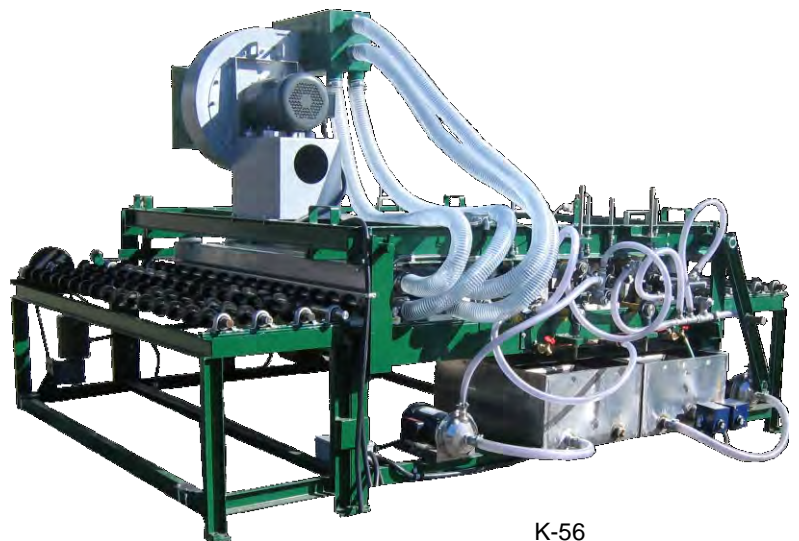

K-56  
Glass Washer

# KEAR Fabrication Inc.

27 Vanley Crescent, North York, Ont., Canada M3J 2B7 • Tel: (416) 398- 8666 • Fax: (416) 398-9666



K-60SS  
Swing & Slide Manipulator



K-60HSS  
Manipulator

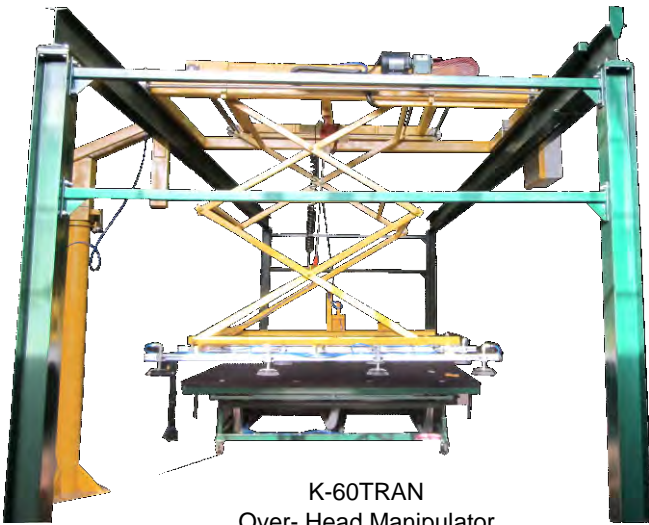

K-60TRAN  
Over-Head Manipulator

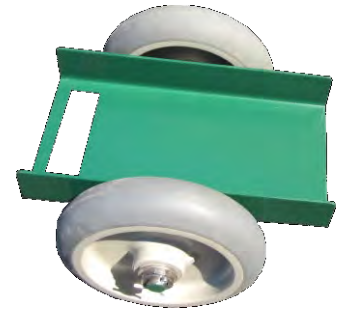

K-54FH  
Floor Dolly



K-60 Manipulator

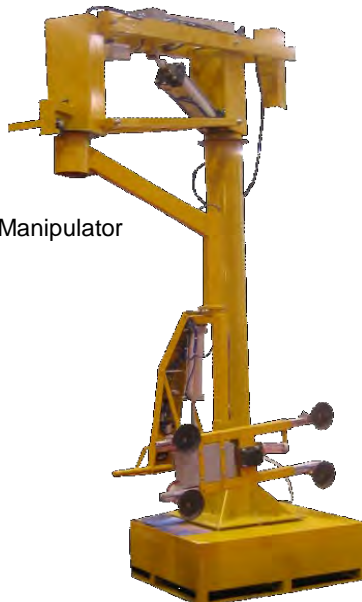

K-60A Manipulator



K-54F  
Floor Dolly



K-54FD  
Floor Dolly

# KEAR Fabrication Inc.



K-60 AM  
Manipulator



K-60 AMH  
Manipulator



K-65S  
Roller Conveyor



K-60VLE  
Lifting Cup Unit

K-69  
Multi Lock Dolly



K-65TG  
Tiger Stop Support Table



K-65WC  
Wire Cutter Table

# KEAR Fabrication Inc.





K-65LF Load/Offload Roller Conveyor



K-66C Corner Connecting Table



K-66 Multi-Head Drill Station



K-65SM Dry Dolly & Painting Dolly

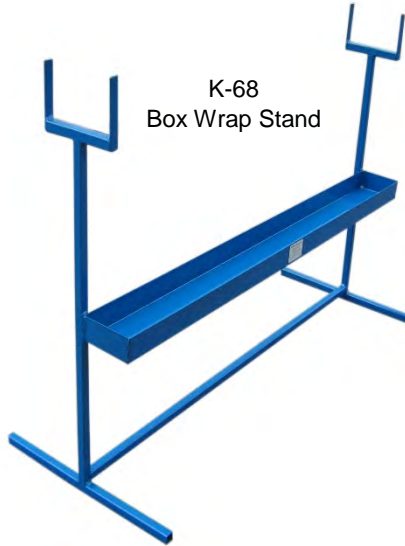

K-68 Box Wrap Stand

K-70PD Dry Dolly & Painting Dolly



K-70DD Dry Dolly & Painting Dolly



K-70V Dry Rack (Glass Painting)



K-70GDD Glass Curing Paint Dolly

# KEAR Fabrication Inc.

27 Vanley Crescent, North York, Ont., Canada M3J 2B7 • Tel: (416) 398- 8666 • Fax: (416) 398-9666



K-70PH  
Painting Table



K-70TEL  
Door Paint Dolly Expandable



K-70DC Window  
And Door Curing



K-70DSR Shape Door Stain & Paint  
Dolly with Manual Rotation and Brake



K-70TED Painting Curing Station



K-70RRP Manual  
Rotate Stand with  
Expandable

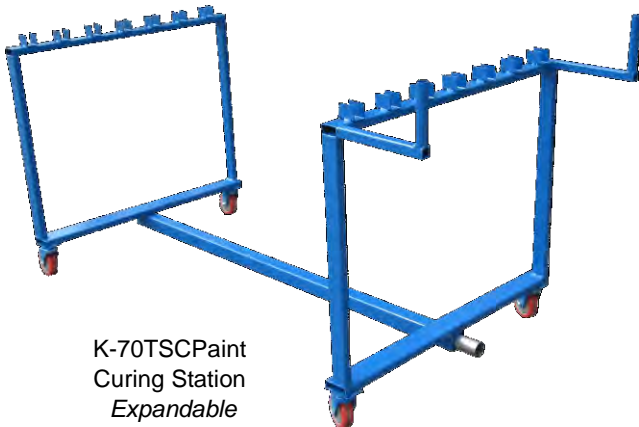

K-70TSC Paint  
Curing Station  
Expandable



K-70AS Solar Rotate Table

# KEAR Fabrication Inc.

27 Vanley Crescent, North York, Ont., Canada M3J 2B7 • Tel: (416) 398- 8666 • Fax: (416) 398-9666

K-80  
Automatic Feet Drill Station



K-76  
Drum Dolly



K-72S  
Strap Table



K-71A  
"A" Type Dolly



K-72  
Shutter Assembly Table  
with Pneumatic Lift



K-70RS Door Stain & Paint  
Dolly with Manual Rotation  
and Brake

# KEAR Fabrication Inc.

27 Vanley Crescent, North York, Ont., Canada M3J 2B7 • Tel: (416) 398- 8666 • Fax: (416) 398-9666



K-82HD  
Hinge & Lock Machine



K-81  
Multi-locks Routing  
Table



K-82  
Patio Door Assembly Table



K-84  
Window Display  
Stand



K-81MRM  
Horizontal Multi-Lock  
Router



# KEAR Fabrication Inc.

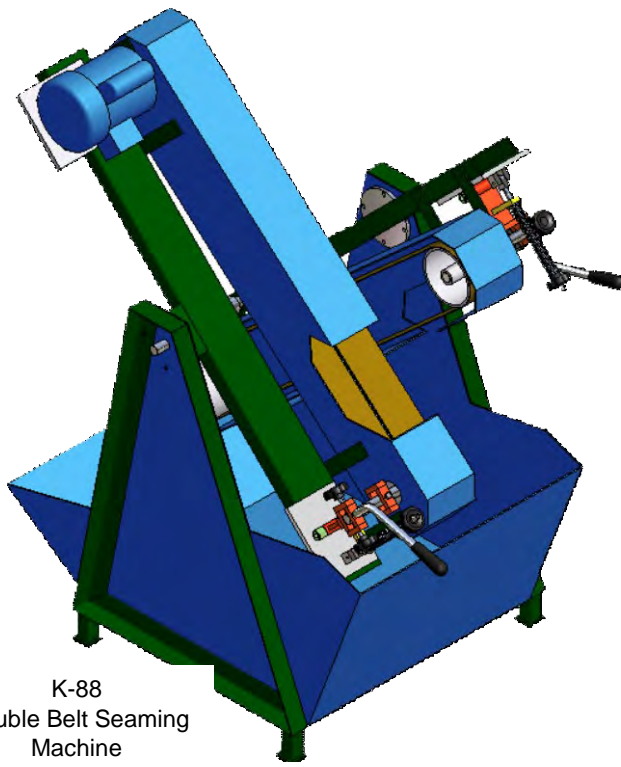

K-88  
Double Belt Seaming  
Machine



K-88DS  
V-Seaming Machine with  
Support table



K-90  
Aluminium Assembly Table

K-91  
Mobile Hoist IMG



K-93  
Spacer Gas Puncher



K-93HYD  
Hydraulic Puncher

# KEAR Fabrication Inc.

27 Vanley Crescent, North York, Ont., Canada M3J 2B7 • Tel: (416) 398- 8666 • Fax: (416) 398-9666